

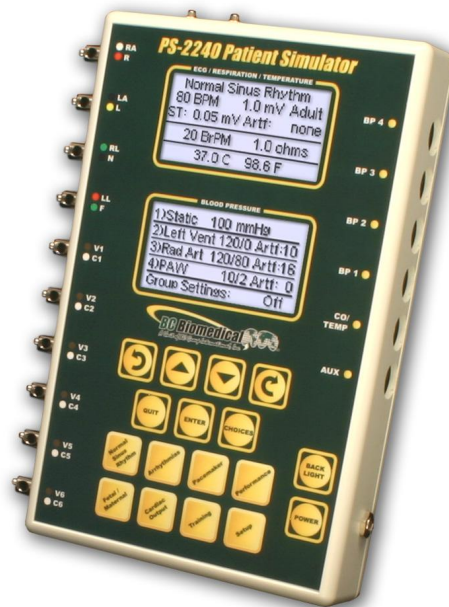

MULTI-PARAMETER PATIENT SIMULATOR



PS-2200 SERIES

USER MANUAL

**BC BIOMEDICAL
PS-2200 SERIES
TABLE OF CONTENTS**

WARNINGS, CAUTIONS, NOTICES	ii
DESCRIPTION.....	1
LAYOUT.....	7
ECG--NORMAL SINUS RHYTHM.....	14
ECG--ARRHYTHMIAS	16
ECG--PACEMAKER.....	25
ECG--PERFORMANCE	27
BLOOD PRESSURE	30
SWAN-GANZ	38
RESPIRATION.....	42
TEMPERATURE	44
TRAINING	45
SETUP	50
POWER UP SETTINGS	53
SpO ₂ (OPTION)	55
FETAL/MATERNAL (OPTION)	56
CARDIAC OUTPUT (OPTION)	59
OUTPUT CONNECTIONS.....	62
MANUAL REVISIONS.....	63
LIMITED WARRANTY	63
SPECIFICATIONS	64
NOTES.....	68

WARNING - USERS

The PS-2200 Series are for use by skilled technical personnel only.

WARNING - USE

The PS-2200 Series are intended for testing only and should never be used in diagnostics, treatment or any other capacity where they would come in contact with a patient.

WARNING - CONNECTIONS

All connections to patients must be removed before connecting the DUT to the PS-2200 Series. A serious hazard may occur if the patient is connected when testing with the PS-2200 Series.

CAUTION - MODIFICATIONS

The PS-2200 Series are intended for use within the published specifications. Any application beyond these specifications or any unauthorized user modifications may result in hazards or improper operation.

CAUTION - SERVICE

The PS-2200 Series are intended to be serviced only by authorized service personnel. Troubleshooting and service procedures should only be performed by qualified technical personnel.

CAUTION - INSPECTION

The PS-2200 Series should be inspected before each use for obvious signs of abuse or wear. The PS-2200 Series should not be used and should be serviced if any parts are in question.

CAUTION - CLEANING

Do not immerse. The PS-2200 Series should be cleaned by wiping gently with a damp, lint-free cloth. A mild detergent can be used if desired.

CAUTION - LIQUIDS

Do not submerge or spill liquids on the PS-2200 Series. Do not operate the PS-2200 Series if exposed to fluid.

CAUTION - ENVIRONMENT

Exposure to environmental conditions outside the specifications can adversely affect the performance of the PS-2200 Series. Allow the PS-2200 Series to acclimate to specified conditions for at least 30 minutes before attempting to operate them.



NOTICE – CE



The PS-2200 Series Simulators bear the  mark
Based on the following testing standards:

ELECTROMAGNETIC COMPATIBILITY DIRECTIVE

**EMC – Directive 89/336/EEC as amended by 92/31/EEC and 93/68/EEC
& Directive 91/263/EEC [TTE/SES]**

**EN 61326-1:1997 + A1:1998 + A2:2001 + A3:2003
“Electrical equipment for measurement, control and
laboratory use – EMC requirements”**

This equipment has been type tested by an independent, accredited testing laboratory
and compliance was demonstrated to the above standard to the extent applicable.

EMISSIONS
Radiated Emissions

EN 61326:1997 Annex C

IMMUNITY– CLASS C

EN 61000-4-2:1995
EN 61000-4-3:2006

Electrostatic Discharge
Radiated Electric Field Immunity

LOW VOLTAGE DIRECTIVE **EC – Directive 73/23/EC**

**EN 61010-1:2001
“Safety requirements for electrical equipment for measurement, control, and
laboratory use – General requirements”**

This equipment has been type tested and compliance was demonstrated
to the above standard to the extent applicable.

NOTICE – SYMBOLS

<u>Symbol</u>	<u>Description</u>
---------------	--------------------



Caution
(Consult Manual for Further Information)



Center Negative



Per European Council Directive 2002/95/EC,
do not dispose of this product as unsorted
municipal waste.

NOTICE – ABBREVIATIONS

AHA	American Heart Association
ANSI	American National Standards Institute
BPM	Beats Per Minute
BrPM	Breaths Per Minute
C	Celsius
cc	cubic centimeters
°	degree(s)
ECG	Electrocardiogram
F	Fahrenheit
Hz	hertz
IEC	International Electrotechnical Commission
IBP	Invasive Blood Pressure
kHz	kilohertz
LED	Light Emitting Diode
L/min	Liters per minute
µV	microvolt(s)
mA	milliamp(s)
mm	millimeter(s)
mmHg	millimeter(s) of Mercury
mV	millivolt(s)
ms	millisecond(s)
NEDA	National Electronic Distributors Association
NSR	Normal Sinus Rhythm
Ω	ohm(s)
Lbs	pounds
RMS	Root Mean Square
USA	United States of America
V	Volt(s)
VDC	Volts Direct Current

NOTICE – DISCLAIMER

BC GROUP INTERNATIONAL, INC. WILL NOT BE RESPONSIBLE FOR ANY INJURIES SUSTAINED DUE TO UNAUTHORIZED EQUIPMENT MODIFICATIONS OR APPLICATION OF EQUIPMENT OUTSIDE OF THE PUBLISHED INTENDED USE AND SPECIFICATIONS.

NOTICE – DISCLAIMER

BC GROUP INTERNATIONAL, INC. RESERVES THE RIGHT TO MAKE CHANGES TO ITS PRODUCTS OR SPECIFICATIONS AT ANY TIME, WITHOUT NOTICE, IN ORDER TO IMPROVE THE DESIGN OR PERFORMANCE AND TO SUPPLY THE BEST POSSIBLE PRODUCT. THE INFORMATION IN THIS MANUAL HAS BEEN CAREFULLY CHECKED AND IS BELIEVED TO BE ACCURATE. HOWEVER, NO RESPONSIBILITY IS ASSUMED FOR INACCURACIES.

NOTICE – CONTACT INFORMATION

BC BIOMEDICAL
BC GROUP INTERNATIONAL, INC.
3081 ELM POINT INDUSTRIAL DRIVE
ST. CHARLES, MO 63301
USA

1-800-242-8428
1-314-638-3800

www.bcgrouptl.com
sales@bcgrouptl.com

BC BIOMEDICAL PS-2200 SERIES PATIENT SIMULATOR

The PS-2200 Family is a series of high end Microprocessor based Patient Simulators. Each model provides ECG, Blood Pressure, Respiration and Temperature Simulation. Models are available with one, two or four independent blood pressure outputs. All models will support the Fetal/Maternal, SpO₂ and Cardiac Output options.

The PS-2200 Family makes viewing and selecting the desired waveforms and parameters quick and intuitive, with all operational information being available at the same time on two cursor-based graphic displays, allowing for easy maneuvering through parameters and scrolling through available options.

The following are highlights of some of the main features:

- SIMPLE TO OPERATE
- NO CODES TO REMEMBER OR ENTER
- GRAPHICS DISPLAY WITH SIMULTANEOUS DETAILED STATUS OF PARAMETERS AND SCROLLING CONTROL OF OPTIONS
- DROP DOWN CHOICE SCREENS LIST ALL OPTIONS FOR PARAMETERS
- SPECIAL POWER UP FEATURE ALLOWS THE USER TO CHOOSE TO USE DEFAULT, LAST OR CUSTOM SETTINGS
- AUTO SEQUENCES FOR BPM, STATIC-PRESSURE LEVELS AND PERFORMANCE
- 10 UNIVERSAL PATIENT LEAD CONNECTORS
- MINI-DIN CONNECTORS FOR BP CABLES
- 9 VOLT BATTERY POWER
- % BATTERY LIFE DISPLAY
- LOW BATTERY INDICATOR
- AVAILABLE BATTERY ELIMINATOR
- DISPLAY BACKLIGHT
- FULL REMOTE OPERATION VIA RS-232
- FLASH PROGRAMMABLE FOR UPGRADES

ECG NSR FUNCTIONS

The unit can produce a wide variety of ECG NSR simulations. The user simply selects the parameters that match the desired output.

- RATE: 30, 40, 45, 60, 80, 90, 100, 120, 140, 160, 180, 200, 220, 240, 260, 280, 300 BPM
- AMPLITUDE (Lead II):
0.05, 0.10, 0.15, 0.20, 0.25, 0.30, 0.35, 0.40, 0.45, 0.50, 1.0, 1.5, 2.0, 2.5, 3.0, 3.5, 4.0, 4.5, 5.0 mV

- S-T SEGMENT ELEVATION:
± 0, 0.05, 0.1, 0.2, 0.3, 0.4, 0.5, 0.6, 0.7, 0.8 mV
- ARTIFACTS:
50 Hz, 60 Hz, MUSCLE, BASELINE WANDER, RESPIRATION
- QRS INTERVAL:
ADULT (80 ms) OR PEDIATRIC (40 ms)
- AUTOMATIC MODE

ARRHYTHMIA FUNCTIONS

The unit can simulate 36 different arrhythmias. For ease of selection, they are grouped into four basic categories. Where applicable, both manual and automatic triggering of the waveform is available.

- 36 DIFFERENT ARRHYTHMIAS
- FOUR GENERAL GROUPS:
SUPRAVENTRICULAR
PREMATURE
VENTRICULAR
CONDUCTION
- MANUAL AND AUTOMATIC TRIGGERING

PACEMAKER FUNCTIONS

Seven different pacemaker waveforms may be simulated. Additionally, the width and amplitude of the pacer pulse may be selected.

- WAVEFORMS:
ATRIAL PACER, ASYNCHRONOUS, NON-CAPTURE,
NON-FUNCTION, DEMAND - OCCASIONAL,
DEMAND – FREQUENT, AV - SEQUENTIAL
- PULSE HEIGHT:
1, 2, 3, 4, 5, 6, 7, 8, 9, 10 mV
- PULSE WIDTH:
0.1, 0.5, 1.0, 1.5, 2.0 ms

ECG-PERFORMANCE FUNCTIONS

The unit will generate Sine, Square, Triangular and Pulse waveforms with adjustable amplitudes for performance testing. A special Automatic mode is available to auto sequence through the entire range of waveforms. Also, a R-Wave (Havertriangle) waveform may be selected with separate amplitude and width settings.

- SINE:
0.1, 0.5, 5, 10, 40, 50, 60, 100 Hz

- SQUARE:
0.125, 2.0 Hz
- TRIANGLE:
2.0, 2.5 Hz
- PULSE:
30, 60, 120 BPM; 60 ms WIDTH
- AMPLITUDE (Lead II):
0.05, 0.10, 0.15, 0.20, 0.25, 0.30, 0.35, 0.40, 0.45, 0.50, 1.0, 1.5,
2.0, 2.5, 3.0, 3.5, 4.0, 4.5, 5.0 mV
- AUTOMATIC MODE
- R WAVE RATE:
30, 60, 80, 120, 200, 250 BPM
- R WAVE WIDTH:
8, 10, 12, 20, 30, 40, 50, 60, 70, 80, 90, 100, 110, 120, 130, 140,
150, 160, 170, 180, 190, 200 ms
- R WAVE AMPLITUDE (Lead II):
0.05, 0.10, 0.15, 0.20, 0.25, 0.30, 0.35, 0.40, 0.45, 0.50, 1.0, 1.5, ,
2.0, 2.5, 3.0, 3.5, 4.0, 4.5, 5.0 mV

RESPIRATION

Respiration is simulated at 8 different rates, with the ability to select from 4 Baseline Impedances, the Lead in which it will appear, and the Delta Ohms (amplitude) of the signal. Additionally, an Apnea period may be selected.

- RATE:
15, 20, 30, 40, 60, 80, 100, 120 BrPM
- BASELINE IMPEDANCE:
500, 1000, 1500, 2000 OHMS
- LEAD:
LA or LL
- DELTA IMPEDANCE:
0.1, 0.2, 0.5, 1.0, 2.0, 3.0 OHMS
- APNEA:
12, 22 and 32 SECONDS PLUS CONTINUOUS

BLOOD PRESSURE

There is one or more (dependent on model) Blood Pressure simulation channels.

Both static and dynamic invasive pressures are simulated. In the static mode, the BP outputs are fixed at the selected level or sequenced through the list using the Automatic mode selection.

In the Dynamic mode, the selected waveform is synchronized with the ECG and provides a continuous output. Additionally, a Respiration Artifact may be added.

A special Swan-Ganz mode is available that will allow Manual or Automatic simulation of that sequence.

Each channel has independent settings.

- STATIC:
-10, -5, 0, 20, 40, 50, 60, 80, 100, 150, 160, 200, 240,
250, 300, 320, 400 mmHg
- AUTOMATIC STATIC PRESSURE MODE
- 8 DYNAMIC WAVEFORMS
- RESPIRATION ARTIFACT:
0 to 16 mmHg
- SENSITIVITY:
5 or 40 $\mu\text{V}/\text{V}/\text{mmHg}$
- SWAN-GANZ SIMULATION
- 7 PRESET STATIC GROUPS (MODEL PS-2240 ONLY)

TEMPERATURE

The unit will simulate seven temperatures. This is done by providing the necessary ohmic levels for both the YSI 400 and 700 Series thermistors.

- YSI 400 SERIES and 700 SERIES SIMULATION
- SELECTIONS:
0, 24, 30, 35, 37, 40, 42 °C
(32.0, 75.2, 86.0, 95.0, 98.6, 104.0, 107.6 °F)

LEAD TEST FUNCTION

The unit provides a set of test terminals to quick check leads. It will determine if a lead has less than 1000 Ohms resistance.

TRAINING

The unit has a special training mode that may be used to aid users in practicing the identification of arrhythmias. A series of settings allows the feature to be customized to fit the exact training requirement.

- TIMER:
MANUAL, 10, 15, 20, 25, 30 SEC
- RANDOMIZER:
OFF, ON
- ARRHYTHMIAS:
ALL, SUBSET

SPO2 SIMULATION (Optional)

When used with the MSP-2100 external module and FingerSim family of SpO₂ finger simulators, the system will provide a pulse synchronized SpO₂ output for all NSR rates.

- RATE:
30, 40, 45, 60, 80, 90, 100, 120, 140, 160, 180, 200, 220,
240, 260, 280, 300 BPM
- SpO₂ OUTPUT:
80, 90, 97 %

FETAL/MATERNAL (Option)

This option provides a combination of fetal and maternal ECG waveforms with and without contractions. Additionally, it provides an Intrauterine-Pressure (IUP) waveform.

- FETAL HEART RATE:
60, 90, 120, 140, 150, 210, 240 BPM
- IUP PERIOD:
SINGLE CONTRACTION (MANUAL)
2, 3, 5, MIN (AUTO)
- FHR (DURING CONTRACTION):
UNIFORM DECELERATION
EARLY DECELERATION
LATE DECELERATION
UNIFORM ACCELERATION

CARDIAC OUTPUT (Option)

When used with the MCO-2100 External Module, this option provides both the hardware and software to simulate Cardiac Output waveforms for testing devices that utilize Baxter – Edwards type catheters.

- INJECTATE TEMPERATURE:
0, 24 °C
- INJECTATE FLOW:
2.5, 5.0, 10.0 L/MIN
- OTHER OUTPUTS:
FAULTY – INJECTATE
LEFT-TO-RIGHT SHUNT
CALIBRATED TEMPERATURE PULSE

OPTIONAL ACCESSORIES

BC20-21100	BATTERY ELIMINATOR (USA Version)
BC20-21101	BATTERY ELIMINATOR (Euro Version)
BC20-02300	FETAL / MATERNAL OPTION
BC20-02400	CARDIAC OUTPUT OPTION
MSP-2100	PULSE OXIMETRY MODULE (ALLOWS PS-2200 TO SIMULATE SpO ₂ OUTPUT WHEN USED WITH FingerSims™)
FingerSim™ KIT	COMPLETE STARTER KIT (INCLUDES 80%, 90% AND 97% FingerSims™, FingerSim™ HOLDER, AND CARRYING CASE)
FingerSim™ SET	REPLACEMENT KIT (INCLUDES 80%, 90% AND 97% FingerSims™ ONLY)
BC20-30107	SOFT-SIDED CARRYING CASE
BC20-41337	COMMUNICATION CABLE (MINI DIN M TO DB-9F)
BC20-41339	COMMUNICATION CABLE (USB TO DB-9M)

INVASIVE BLOOD PRESSURE CABLES

FOR A COMPLETE LIST CONSULT THE BC GROUP WEBSITE AT
WWW.BCGROUPINTL.COM

TEMPERATURE SIMULATION CABLES

BC20-41333	UT-1 YSI-400
BC20-41334	UT-2 YSI-700

CARDIAC OUTPUT CABLES

BC20-41335	HP INJECTATE CABLE ASSEMBLY
BC20-41336	HP TEMP CABLE

LAYOUT

This section looks at the layout of a PS-2200 and gives descriptions of the elements that are present.

10 Universal Patient Lead Connectors:

RA	R
LA	L
RL(-)	N
LL	F
V1	C1
V2	C2
V3	C3
V4	C4
V5	C5
V6	C6

7 Light Touch Keys for Selecting Parameters and Settings:

LEFT and RIGHT Curved Arrows for Moving through Parameters
 UP and DOWN Arrows for Scrolling through Options
 ENTER for Selecting Option
 CHOICES for Displaying Submenu of All Options for a Given Parameter
 QUIT for Returning to Previous Status

8 Light Touch Keys for Category Selection:

Normal Sinus Rhythm
 Arrhythmias
 Pacemaker
 Performance
 Fetal/Maternal
 Cardiac Output
 Training
 Setup

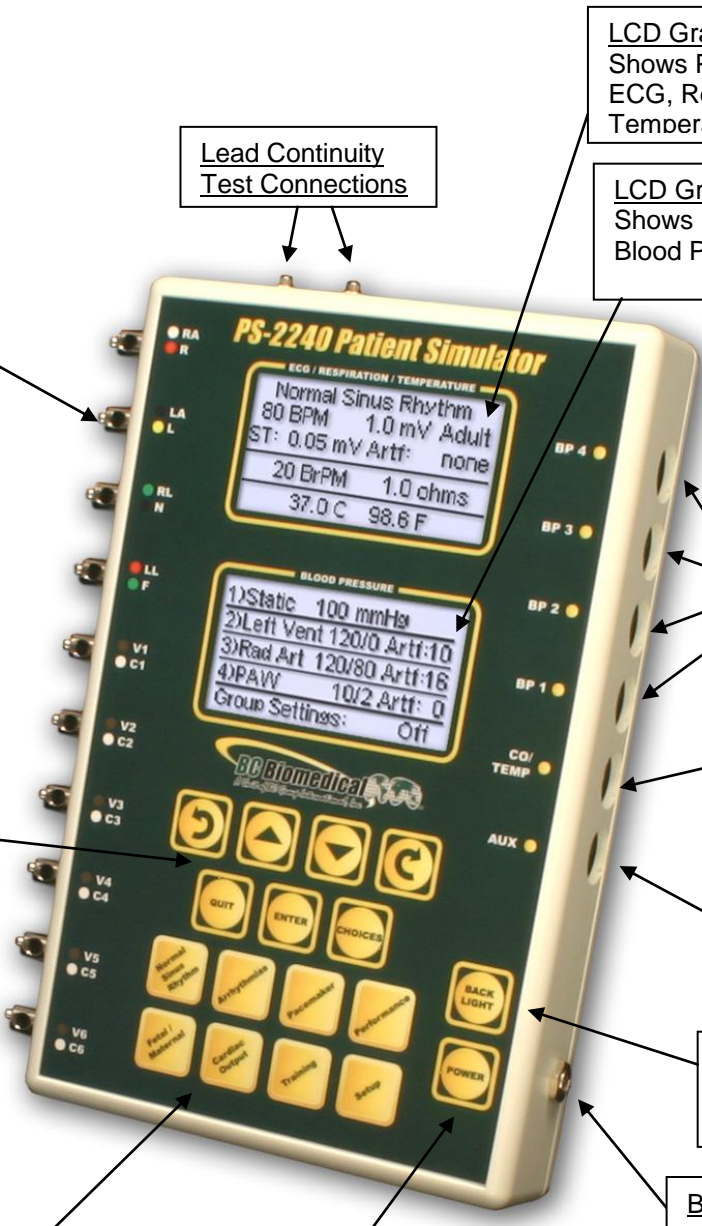

Lead Continuity Test Connections

LCD Graphical Display 1:
Shows Parameters for ECG, Respiration and Temperature

LCD Graphical Display 2:
Shows Parameters for Blood Pressure

6-Pin Mini-DIN Plug Connectors for Blood Pressure Cables

8-Pin Mini-DIN Plug Connector for Temperature/CO Cable

7-Pin Mini-DIN Plug Connector for Aux Functions







Back Light Key for turning on and off the backlight





Battery Eliminator Jack











Power Key for Turning Unit On and Off

General Operation

The unit is controlled by 17 light touch keys. They allow the user to move around within the displayed parameters, select the desired options, choose a specific category and control the setup and power for the unit. When a key is depressed there is an audio click when it is accepted, or a razz tone if the key is invalid.

Two graphics LCD displays provide the user with information about the current status of the ECG, Respiration, Temperature and Blood Pressure settings. The   keys move the block cursor through the displayed information; highlighting the parameter available for selection. The   keys change the options for the highlighted parameter. The cursor begins flashing if the parameter has been changed. The  key selects the changed option. The  key returns to the previous state, without any changes being made.

To make option selection even easier and to make memorizing and using codes unnecessary, the  key will bring up a screen that displays all the options for the selected parameter. The   and  keys can then be used to quickly scroll through the available options and select the desired setting.

Seven category keys allow for quick setting of output waveforms. The  ,  ,  ,  ,  ,  and  keys move the display directly to the selected category. The   or  keys can then be used to scroll through and select the desired settings.

The  key opens a screen that allows the user to select the unit's general output settings, as well as setup for the system.

Category Keys

The  key enters the NSR category.

The  key enters the arrhythmia category and changes the first line in the display to the first arrhythmia choice.

The  key enters the pacemaker category and changes the first line in the display to the first pacemaker waveform choice.

The  key enters the machine performance testing category and changes the first line in the display to the first performance waveform choice.

The  key opens a screen that allows the user to set the conditions for and start the optional Fetal/Maternal mode. (Optional)

The  key opens a screen that allows the user to set the conditions for and start the optional Cardiac Output mode. (Optional)

The  key opens a screen that allows the user to set the conditions for and start the special training mode.

Power Key

The  key turns the unit on and off. To turn off the unit, the key must be held for 1 second.

Backlight

The Graphic LCD display may be viewed with or without the backlight. Depressing any key will activate the backlight. However, since the backlight will drain the battery if left on, it will automatically shut off after a few seconds when running on battery power. (Note: This time is selectable in the System Setup screen).

The intensity of the backlight can be adjusted in the System Setup screen to conserve battery life.

The  key is provided to toggle the backlight on or off at any time.

NOTE: The backlight parameter in the System Setup screen may be set to Off, 1-30 sec Timed or Manual.

ECG Waveforms

The microprocessor has stored in its memory all of the digitalized waveforms. It sends the individual lead waveforms to D/A converters, which generate accurate analog representations. The waveforms are then sent through resistor networks, developing the appropriate signals on the output terminals.

Respiration

Respiration waveforms are provided that have adjustable rates from 15 to 120 BrPM (Breaths Per Minute) as well as an Apnea (0 BrPM) setting. The signal is generated by a variation in the impedance in either the LL or LA lead (selectable). The amplitude is settable from .5 to 3.0 ohms.

Blood Pressure

There are one, two or four 6-pin mini-DIN plug connectors on the right side of the unit for connection of the Blood Pressure cables. Full blood pressure simulation is available through these connectors. The circuits are totally isolated.

Temperature

There is an 8-pin mini-DIN plug connector on the right side of the unit for connection of a Temperature cable. Temperatures are simulated for both YSI 400 and YSI 700 probe types. There are seven different temperatures selectable for each.

Universal Patient Lead Connectors

The 10 Universal Patient Lead Connectors allow for 12 lead ECG simulation with independent outputs. AHA and IEC color-coded labels are located on the face of the unit to aid in connecting the corresponding U.S. and International Patient Leads.

AHA Label	IEC Label	Description
RA	R	Right Arm
LA	L	Left Arm
RL	N	Right Leg (reference or ground)
LL	F	Left Leg
V1 V2 V3 V4 V5 V6	C1 C2 C3 C4 C5 C6	V Leads (V1-V6) (U.S. and Canada) also referred to as pericardial, precordial or unipolar chest leads Chest Leads (C1-C6) (International)

High Level Output (+)

A high level ECG output signal (200 x Amplitude Setting) is available in the BP1 6-Pin mini-DIN connector.

Auto Power Off

The unit may be programmed to automatically turn off after a selected number of minutes of no key activity to conserve the battery. (Note: This time is selectable in the System Setup screen).

Power Supply

The unit utilizes two 9 Volt Alkaline Batteries in the rear battery compartment. When the unit detects a LOW BATTERY condition (5% Battery Life), a warning window will appear once per minute to alert the user. The  key may be used to clear this window and

continue use of the unit. If the battery is not replaced before the battery reaches a critical level (0 % Battery Life), the unit will shut down. (The percentage of life left in the batteries can be viewed in the System Setup screen.)

Battery Eliminator

The unit has a 2.1 mm jack for connecting the Battery Eliminator (Optional).



Note: The Battery Eliminator will not charge the battery.

Power Up Settings

The unit may be setup to turn on using either the factory default settings, the same settings that it had when last turned off or a custom set of parameters as previously saved by the user (See Power Up Settings section for details).

Automatic Modes

The ECG NSR Rate, ECG Performance and Static Blood Pressure Parameters all allow for an automatic setting. In each of these, the unit will sequence through the full range of settings automatically at a fixed rate (as selected in the Auto Step Time Parameter). When in this mode, the time remaining in each step is displayed.

The  key may be used to manually advance to the next step. The  key is used to terminate the mode.

ECG – NORMAL SINUS RHYTHM





The PS-2200 can send waveforms to ECG machines in 3, 5 or 12 lead configurations. It has independent outputs for each signal lead, referenced to the right leg.



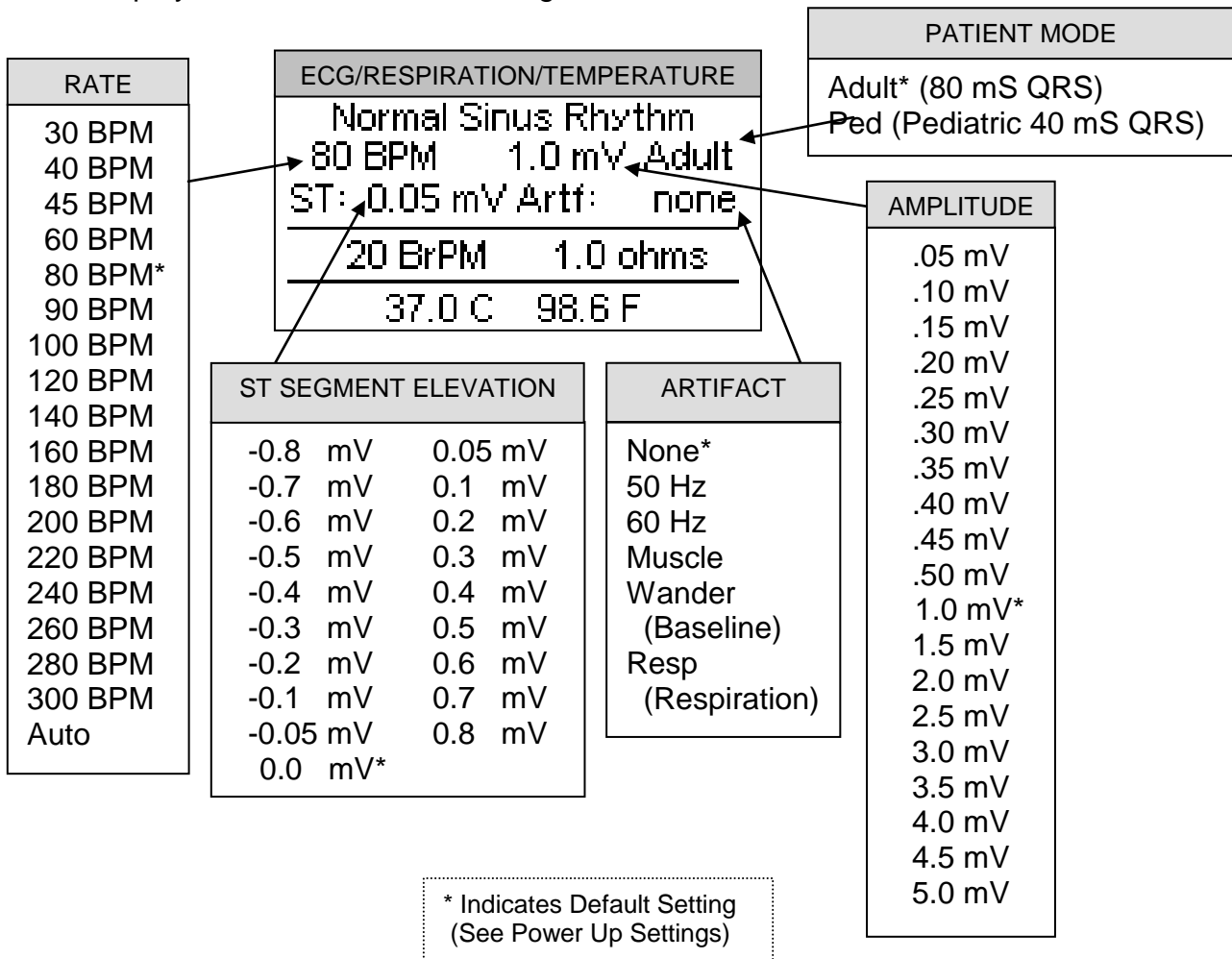

Normal Sinus Rhythm (NSR) occurs when the heartbeat is normal, beating at a rate between 50 and 100 BPM with a standard QRS waveform shape and height. The PS-2200 simulates the NSR with a default pulse of 80 BPM, amplitude of 1.0 mV on Lead II, P-R interval of 160 milliseconds, no Artifact and no ST Segment elevation.

The PS-2200 is placed into NSR mode by pressing the  category key.

The display will resemble the following:



The rate, amplitude, adult/pediatric, artifact and ST elevation or depression can be selected by using   to scroll   to highlight the parameter to change and using  is used to accept the new setting.

Alternately, to see a submenu of all the options for a highlighted parameter, use . Use   to scroll to the desired option. Then  is used to accept the new setting.

Auto Rate

If the BPM parameter is set to AUTO, the unit will automatically sequence through all of the BPM settings, starting with 30 BPM, incrementing at a fixed interval. The interval may be set in the System Setup Menu under “Auto Step Time”.

Normal Sinus Rhythm
 30 ^{BPM}(25) 1.0 mV Adult
 ST: 0.05 mV Artf: none

20 BrPM 1.0 ohms

37.0 C 98.6 F

Displays time (seconds) remaining before advancing to next rate.

The  key can be used to exit the Auto Mode during the sequence.

NOTE: ST Elevation or Depression is only active in Adult NSR at or below 180 BPM.

ECG – ARRHYTHMIAS





The PS-2200 can send Arrhythmia waveforms to ECG machines in 3, 5 or 12-lead configurations. It has independent outputs for each signal lead, referenced to the right leg.



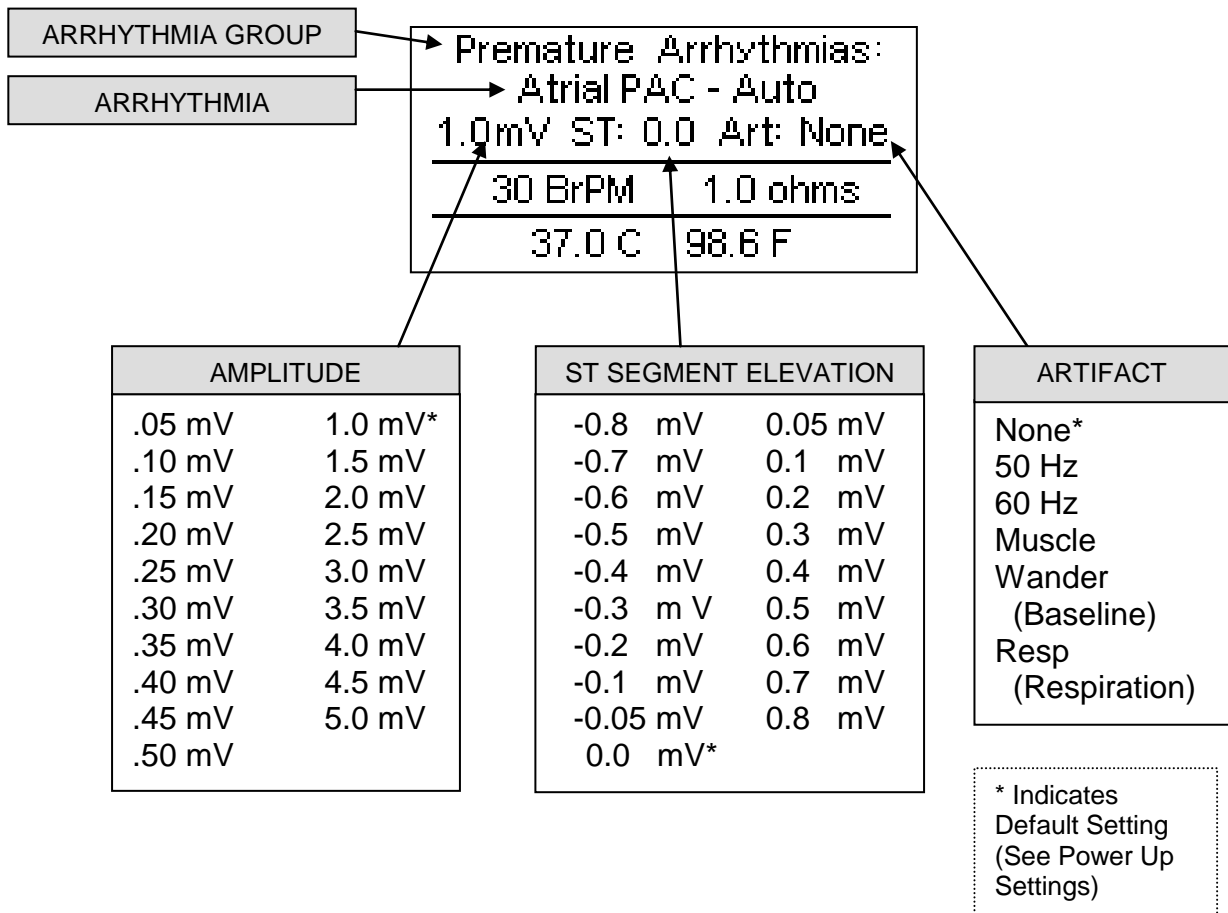

There are 36 Arrhythmias available that model abnormal heartbeats. The PS-2200 is placed into ARRHYTHMIA mode by pressing the  category key.

The top portion of the display shows the currently enabled arrhythmia group and selection, selectable from:

Premature	Supraventricular	Ventricular	Conduction
Atrial PAC - Auto*	Atrial Fib - Coarse	Pair of PVCs - Auto	1 st Deg Heart Block
Atrial PAC - Man	Atrial Fib - Fine	Pair of PVCs - Man	2 nd Deg Heart Block
Nodal PNC - Auto	Atrial Flutter	Run of 5 PVCs - Auto	3 rd Deg Heart Block
Nodal PNC - Man	Atrial Tach	Run of 5 PVCs - Man	Rt Bundle Branch Block
PVC 1 - Auto	Paroxysmal Atrial Tach	Run of 11 PVCs - Auto	Lf Bundle Branch Block
PVC 1 - Man	Supravent Tach	Run of 11 PVCs - Man	
PVC 1 Early - Auto	Sinus Arrhythmia	6 PVCs per Min	
PVC 1 Early - Man	Missed Beat - Auto	12 PVCs per Min	
PVC 1 R on T - Auto	Missed Beat - Man	24 PVCs per Min	
PVC 1 R on T - Man	Nodal Rhythm	Freq Multifocal PVCs	
PVC 2 - Auto		Bigeminy	
PVC 2 - Man		Trigeminy	
PVC 2 Early - Auto		Vent Tach	
PVC 2 Early - Man		Vent Fib - Coarse	
PVC 2 R on T - Auto		Vent Fib - Fine	
PVC 2 R on T - Man		Asystole	
Multifocal PVCs - Auto			
Multifocal PVCs - Man			



The grouping, arrhythmias and amplitude can be selected by using   to highlight the parameter to change and using   to scroll to the desired option. Then  is used to accept the new setting.

Alternately, to see a submenu of all the options for a highlighted parameter, use  Use   to scroll to the desired option. Then  is used to accept the new setting.

NOTE: While in the Arrhythmia Group choice screen, the  key may be used for a second time to jump directly to the arrhythmias choices for that group.

Auto/Manual

There are 12 arrhythmias that have both Automatic and Manual versions. Both versions output the same waveform; however, in the Manual version, the arrhythmia is triggered each time  is depressed. In the Auto versions, the arrhythmia is automatically triggered periodically.

The following is a brief description of how the PS-2200 simulates the available Arrhythmias:

PREMATURE		
Abbreviation	Arrhythmia	Description
Atrial PAC – Auto	Premature Atrial Contraction	NSR of 80 BPM with Periodic Abnormal 25 % early P waves (PAC, 7 NSR) (Continuous)
Atrial PAC – Man	Premature Atrial Contraction	NSR of 80 BPM with Periodic Abnormal 25 % early P waves (One-Time event)
Nodal PNC – Auto	Premature Nodal Contraction	NSR of 80 BPM with Periodic Abnormal 25 % early Nodal beat (PNC, 7 NSR) (Continuous)
Nodal PNC – Man	Premature Nodal Contraction	NSR of 80 BPM with Periodic Abnormal 25 % early Nodal beat (One-Time event)
PVC 1 – Auto	Standard Type 1 Premature Ventricular Contraction	NSR of 80 BPM with periodic left focus premature ventricular beats with 20% premature timing (PVC Type 1, 9 NSR) (Continuous)
PVC 1 – Man	Standard Type 1 Premature Ventricular Contraction	NSR of 80 BPM with periodic left focus premature ventricular beats with 20% premature timing (One-Time event)
PVC 1 Early - Auto	Early Type 1 Premature Ventricular Contraction	NSR of 80 BPM with periodic left focus premature ventricular beats with 33% premature timing (PVC Type 1, 9 NSR) (Continuous)
PVC 1 Early - Man	Early Type 1 Premature Ventricular Contraction	NSR of 80 BPM with periodic left focus premature ventricular beats with 33% premature timing (One-Time event)
PVC 1 R on T – Auto	R on T Type 1 Premature Ventricular Contraction	NSR of 80 BPM with periodic left focus premature ventricular beats with 65% premature timing, placing R on the previous T (PVC Type 1, 9 NSR) (Continuous)
PVC 1 R on T – Man	R on T Type 1 Premature Ventricular Contraction	NSR of 80 BPM with periodic left focus premature ventricular beats with 65% premature timing, placing R on the previous T (One-Time event)

PVC 2 – Auto	Standard Type 2 Premature Ventricular Contraction	NSR of 80 BPM with periodic right focus premature ventricular beats with 20% premature timing (PVC Type 2, 9 NSR) (Continuous)
PVC 2 – Man	Standard Type 2 Premature Ventricular Contraction	NSR of 80 BPM with periodic right focus premature ventricular beats with 20% premature timing (One-Time event)
PVC 2 Early - Auto	Early Type 2 Premature Ventricular Contraction	NSR of 80 BPM with periodic right focus premature ventricular beats with 33% premature timing (PVC Type 2, 9 NSR) (Continuous)
PVC 2 Early - Man	Early Type 2 Premature Ventricular Contraction	NSR of 80 BPM with periodic right focus premature ventricular beats with 33% premature timing (One-Time event)
PVC 2 R on T – Auto	R on T Type 2 Premature Ventricular Contraction	NSR of 80 BPM with periodic right focus premature ventricular beats with 65% premature timing, placing R on the previous T (PVC Type 2, 9 NSR) (Continuous)
PVC 2 R on T – Man	R on T Type 2 Premature Ventricular Contraction	NSR of 80 BPM with periodic right focus premature ventricular beats with 65% premature timing, placing R on the previous T (One-Time event)
Multifocal PVCS – Auto	Multifocal Premature Ventricular Contraction	NSR of 80 BPM with Type 1 and Type 2 PVCs (PVC Type 1, 2 NSR, PVC Type 2, 2 NSR) (Continuous)
Multifocal PVCS – Man	Multifocal Premature Ventricular Contractions	NSR of 80 BPM with Type 1 and Type 2 PVCs (PVC Type 1, 2 NSR, PVC Type 2) (One-Time event)

SUPRAVENTRICULAR		
Abbreviation	Arrhythmia	Description
Atrial Fib – Coarse	Atrial Fibrillation	Absence of P-wave, irregular P-R interval rate and a high level signal (Continuous)
Atrial Fib – Fine	Atrial Fibrillation	Absence of P-wave, irregular P-R interval rate and a low level signal (Continuous)
Atrial Flutter	Atrial Flutter	Repeating sequence of 5 atrial beats and 1 ventricular beat for twelve seconds, followed by a repeating sequence of 3 atrial beats and 1 ventricular beat for six seconds, followed by a repeating sequence of 2 atrial beats and 1 ventricular beat for six seconds (Continuous)
Atrial Tach	Atrial Tachycardia	160 BPM (Continuous)
Paroxysmal Atrial Tach	Paroxysmal Atrial Tachycardia	160 BPM for five seconds 80 BPM for ten seconds (Continuous)
Supravent Tach	Supraventricular Tachycardia	200 BPM (Continuous)
Sinus Arrhythmia	Sinus Arrhythmia	Normal beats at a fluctuating rate from 60 BPM to 100 BPM (Continuous)
Missed Beat – Auto	Missed Beat	NSR of 80 BPM with a missed beat (Missed Beat, 36 NSR) (Continuous)
Missed Beat – Man	Missed Beat	NSR of 80 BPM with a missed beat (One-Time Event)
Nodal Rhythm	Nodal Rhythm	60 BPM with very short P-R interval (Continuous)

VENTRICULAR		
Abbreviation	Arrhythmia	Description
Pair of PVCs – Auto	Pair of Premature Ventricular Contractions	NSR of 80 BPM with Periodic Group of 2 Type 1 PVCs (2 PVC Type 1, 36 NSR) (Continuous)
Pair of PVCs – Man	Pair of Premature Ventricular Contractions	NSR of 80 BPM with Periodic Group of 2 Type 1 PVCs (One-Time Event)
Run of 5 PVCs – Auto	Run of 5 Premature Ventricular Contractions	NSR of 80 BPM with periodic group of 5 Type 1 PVCs (5 PVC Type 1, 36 NSR) (Continuous)
Run of 5 PVCs – Man	Run of 5 Premature Ventricular Contractions	NSR of 80 BPM with periodic group of 5 Type 1 PVCs (One-Time event)
Run of 11 PVCs – Auto	Run of 11 Premature Ventricular Contractions	NSR of 80 BPM with periodic group of 11 Type 1 PVCs (11 PVC Type 1, 36 NSR) (Continuous)
Run of 11 PVCs – Man	Run of 11 Premature Ventricular Contractions	NSR of 80 BPM with periodic group of 11 Type 1 PVCs (One-Time event)
6 PVCs per Min	6 Premature Ventricular Contractions per minute	NSR of 80 BPM with 6 Type 1 PVCs per minute (Continuous)
12 PVCs per Min	12 Premature Ventricular Contractions per minute	NSR of 80 BPM with 12 Type 1 PVCs per minute (Continuous)
24 PVCs per Min	24 Premature Ventricular Contractions per minute	NSR of 80 BPM with 24 Type 1 PVCs per minute (Continuous)
Freq Multifocal PVCs	Frequent Multifocal Premature Ventricular Contractions	NSR of 80 BPM with every fourth beat being an alternating Type 1 and Type 2 PVC (Continuous)
Bigeminy	Bigeminal Rhythm	NSR of 80 BPM with every other beat a Type 1 PVC (Continuous)
Trigeminy	Trigeminal Rhythm	NSR of 80 BPM with every third beat a Type 1 PVC (Continuous)

Vent Tach	Ventricular Tachycardia	160 BPM, No P-wave, Beats similar to Type 1 PVC (Continuous)
Vent Fib – Coarse	Ventricular Fibrillation	Irregular waveform with no real P-wave or clear R-R interval and a high signal level (Continuous)
Vent Fib – Fine	Ventricular Fibrillation	Irregular waveform with no real P-wave or clear R-R interval and a low signal level (Continuous)
Asystole	Asystole	Flat line signal (Continuous)

CONDUCTION		
Abbreviation	Arrhythmia	Description
1st Deg Heart Block	First Degree Heart Block	80 BPM with a long P-R interval of 250 ms (Continuous)
2nd Deg Heart Block	Second Degree Heart Block	80 BPM with increasing P-R interval for four beats (160, 220, 400, 470 ms) followed by a P wave without a QRS (Continuous)
3rd Deg Heart Block	Third Degree Heart Block	80 BPM with P wave rate of 80 BPM and QRS rate of 30 BPM (Continuous)
Rt Bundle Branch Block	Right Bundle Branch Block	80 BPM with Normal P-wave and P-R interval but wider QRS complexes (Continuous)
Lf Bundle Branch Block	Left Bundle Branch Block	80 BPM with Normal P-wave and P-R interval but wider QRS complexes (Continuous)





ECG – PACEMAKER



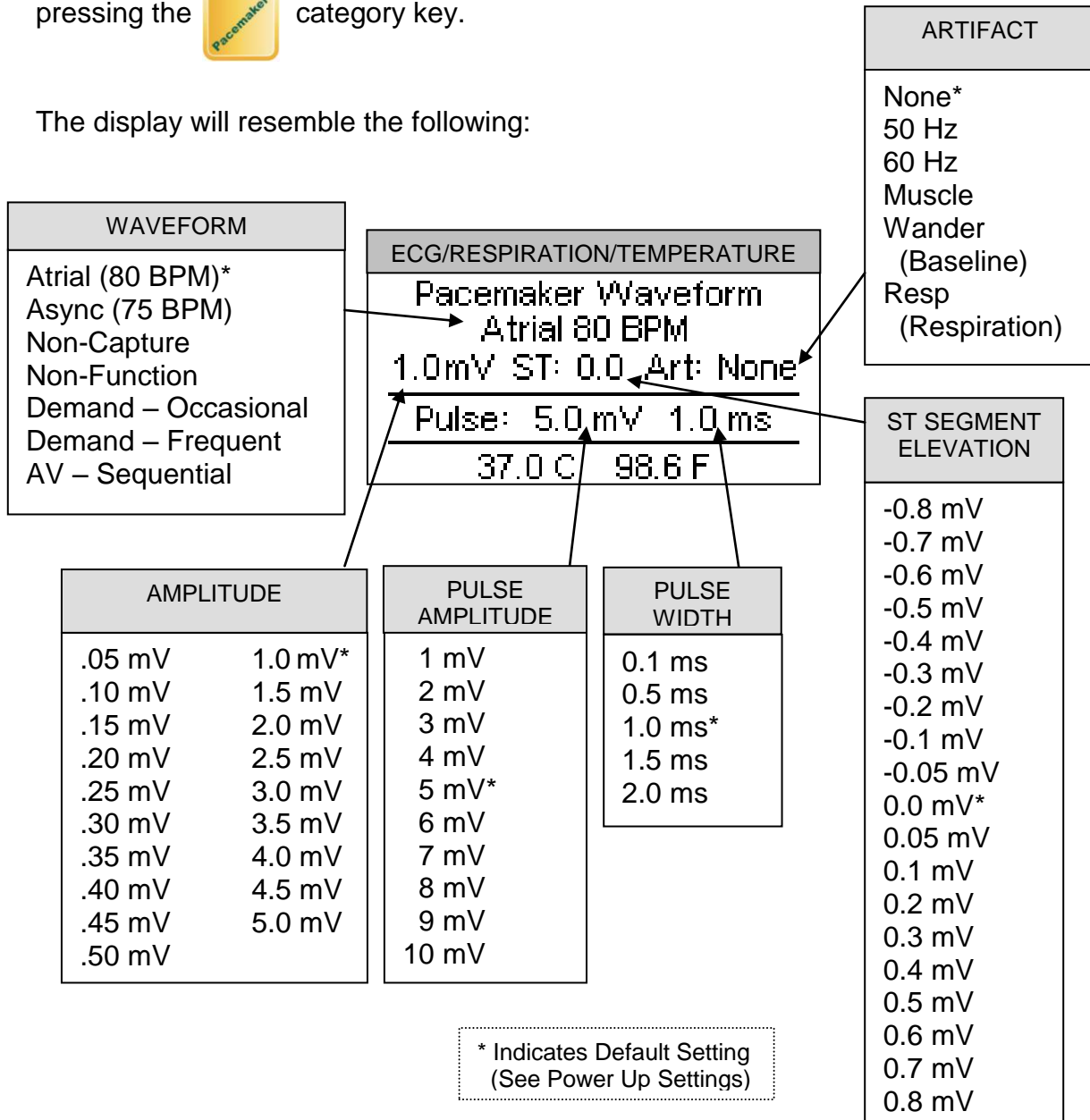

The PS-2200 can send paced waveforms to ECG machines in 3, 5 or 12 lead configurations. It has independent outputs for each signal lead, referenced to the right leg.

There are 7 paced simulation signals available which model when the heartbeat is accompanied by a pacemaker. The PS-2200 is placed into PACEMAKER mode by pressing the  category key.

The display will resemble the following:



The pacemaker rhythms and signals can be selected by using   to highlight the parameter to change and using   to scroll to the desired option. Then  is used to accept the new setting.

Alternately, to see a submenu of all the options for a highlighted parameter, use . Use   to scroll to the desired option. Then  is used to accept the new setting.

The following is a brief description of how the PS-2200 simulates the available Pacemaker Waveforms:

PACEMAKER		
Abbreviation	Waveform	Description
Atrial Pacer	Atrial Pacemaker Wave	80 BPM with Pacer Pulse at the start of each P wave
Asynchronous	Asynchronous Pacemaker Wave	75 BPM with Pacer Pulse at the start of each QRS wave and no P wave
Non-Capture	Ventricular Pacemaker Wave with Periodic Non-Response	75 BPM Ventricular Paced beats with every tenth beat not responding
Non-Function	Ventricular Pacemaker Wave with no Heart Response	75 BPM Ventricular Paced beats with no heart response
Demand – Occasional	Demand Pacemaker Wave with Occasional Sinus Beats	20 NSR beats followed by 20 Ventricular Paced beats
Demand – Frequent	Demand Pacemaker Wave with Frequent Sinus Beats	40 NSR beats followed by 40 Ventricular Paced beats
AV – Sequential	AV-Sequential Pacemaker Wave	75 BPM with Pacer Pulse at the start of both the P and QRS waves

ECG – PERFORMANCE

The PS-2200 can send performance waveforms to ECG machines in 3, 5 or 12-lead configurations. It has independent outputs for each signal lead, referenced to the right leg.

There are 15 Performance waves and 6 R-waves available for testing and verifying. The

PS-2200 is placed into PERFORMANCE mode by pressing the  category key.

The display will resemble the following:

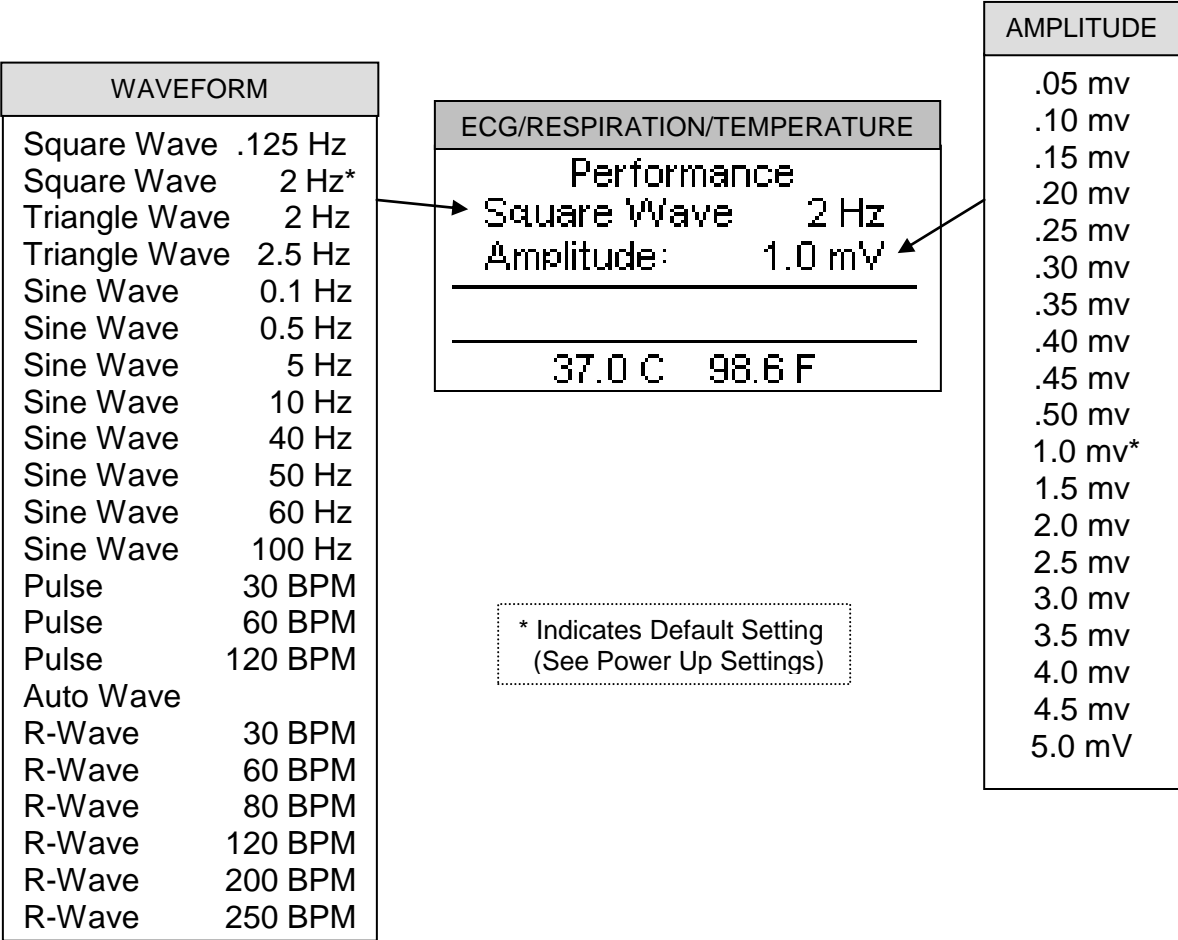





R-Wave





When one of the 6 R-Wave waveforms is selected, the display changes to allow the setting of the width.

WIDTH
8 ms
10 ms*
12 ms
20 ms
30 ms
40 ms
50 ms
60 ms
70 ms
80 ms
90 ms
100 ms
120 ms
130 ms
140 ms
150 ms
160 ms
170 ms
180 ms
190 ms
200 ms

ECG/RESPIRATION/TEMPERATURE	
Performance	
R-Wave	60 BPM
Amplitude:	1.0 mV
Width:	8 ms
37.0 C 98.6 F	

* Indicates Default Setting
(See Power Up Settings)

These widths can be selected by using   to highlight the parameter to change and using   to scroll to the desired option. Then  is used to accept the new setting.

Alternately, to see a submenu of all the options for a highlighted parameter, use . Use   to scroll to the desired option. Then  is used to accept the new setting.

Auto Wave

If the Performance parameter is set to AUTO, the unit will automatically sequence through all of the performance waves, starting with Square Wave .125 Hz, incrementing at a fixed interval. The interval may be set in the System Setup Menu under “Auto Step Time”.

A countdown timer is shown in the display:

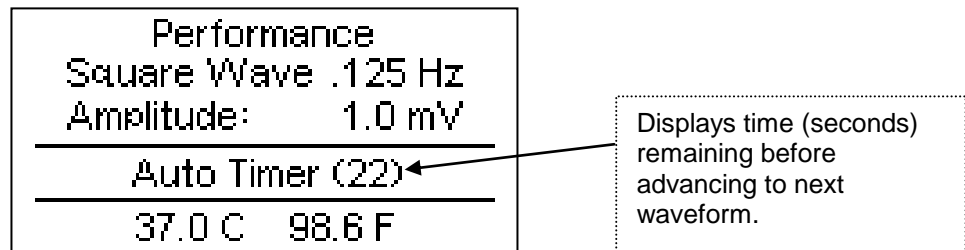

The  key can be used to exit the Auto Mode during the sequence.

BLOOD PRESSURE

NOTE: The Transducer Sensitivity (5 or 40 $\mu\text{V}/\text{V}/\text{mmHg}$) must be set to correlate with the monitoring equipment before simulation can begin. (See SETUP for selection information).

The PS-2200 series offers one, two or four Blood Pressure Channels and will simulate the set Blood Pressure wave during ECG waveforms where it occurs.

Model Number	Blood Pressure Channels
PS-2210	1 Blood Pressure Output
PS-2220	2 Blood Pressure Outputs
PS-2240	4 Blood Pressure Outputs
NOTE: All settings are available on each output.	

There are 16 Blood Pressure settings available, 17 static and 8 dynamic. Each of the dynamic waveforms will synchronize with the NSR rate or arrhythmia selection.

Both an automatic and manual Swan-Ganz simulation are also available.



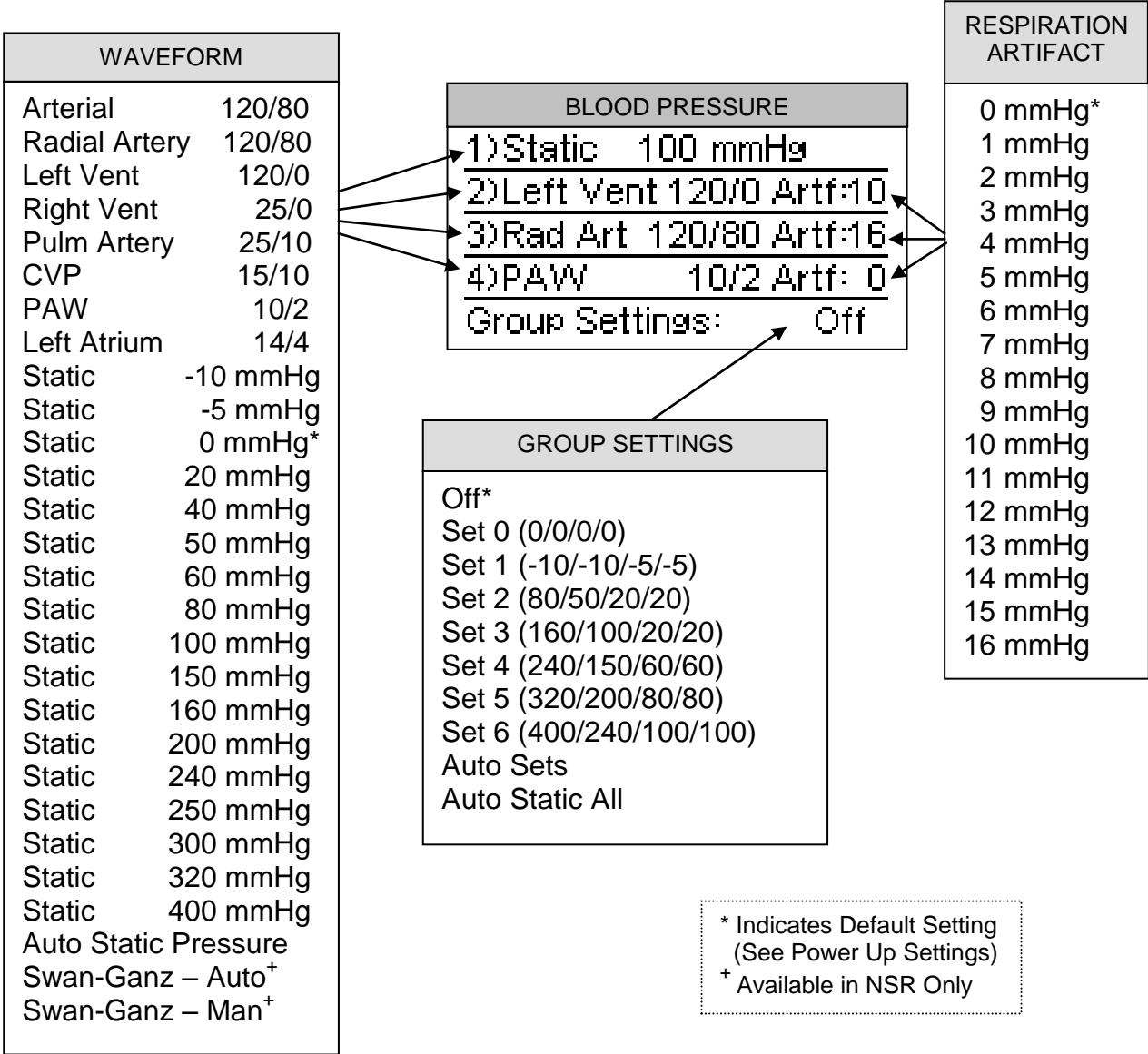

Each of the models has a slightly different display to optimize the individual features.

PS-2240

The PS-2240 quad blood pressure display will resemble the following:



These settings can be selected by using to highlight the parameter to change and using to scroll to the desired option. Then is used to accept the new setting.

Alternately, to see a submenu of all the options for a highlighted parameter, use . Use   to scroll to the desired option. Then  is used to accept the new setting.

Auto Static Pressure

If Auto Static Pressure is selected, the channel will automatically sequence through all of the Static Pressure settings, starting with -10 mmHg, incrementing at a fixed interval. The interval may be set in the System Setup Menu under “Auto Step Time.”

NOTE: Each channel can be set independently.

BLOOD PRESSURE	
1)Static	-10 mmHg (21)
2)Left Vent	120/0 Artf:10
3)Rad Art	120/80 Artf:16
4)PAW	10/2 Artf: 0
Group Settings:	Off

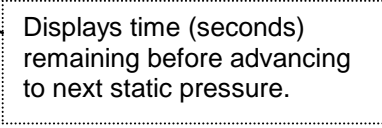
 Displays time (seconds) remaining before advancing to next static pressure.

The  key can be used to exit the Auto Mode during the sequence.

Auto Sets

If Auto Preset is selected, the channels will automatically sequence through the static sets, starting with Set 0, incrementing at a fixed interval. The interval may be set in the System Setup Menu under “Auto Step Time”.

BLOOD PRESSURE	
1) Static	0 mmHg
2) Static	0 mmHg
3) Static	0 mmHg
4) Static	0 mmHg
Group Settings: Auto (23)	

Displays time (seconds) remaining before advancing to next preset.

Auto Static All

If Auto Static All is selected, all channels will automatically sequence through all of the static pressure settings, starting with -10 mmHg, incrementing at a fixed interval. The interval may be set in the System Setup Menu under “Auto Step Time.”

BLOOD PRESSURE	
1) Static	-10 mmHg
2) Static	-10 mmHg
3) Static	-10 mmHg
4) Static	-10 mmHg
Group Settings: Auto (24)	



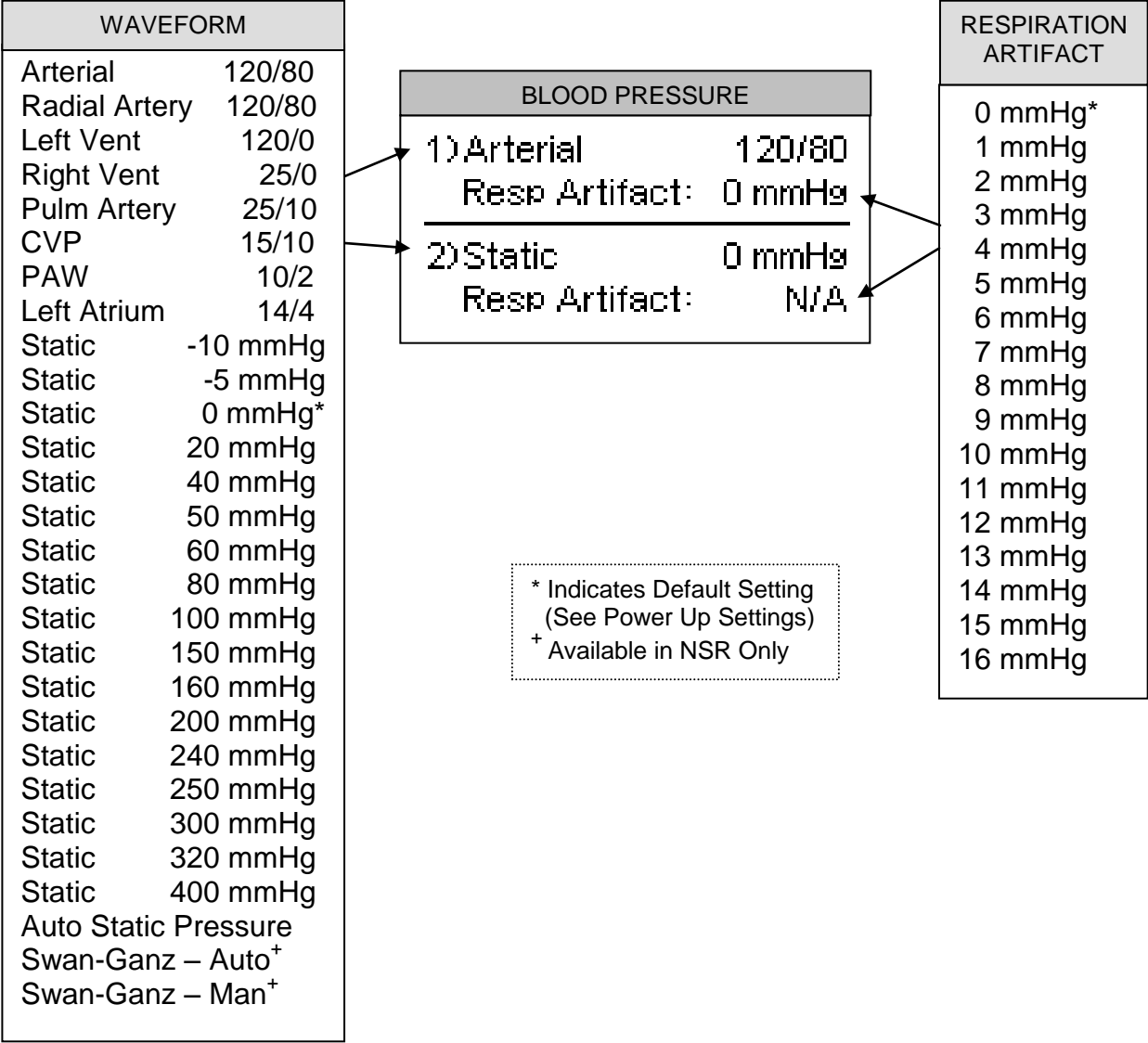

Displays time (seconds) remaining before advancing to next preset.

PS-2220

The PS-2220 dual blood pressure display will resemble the following:



These settings can be selected by using to highlight the parameter to change and using to scroll to the desired option. Then is used to accept the new setting.

Alternately, to see a submenu of all the options for a highlighted parameter, use . Use   to scroll to the desired option. Then  is used to accept the new setting.

Auto Static Pressure

If Auto Static Pressure is selected, the channel will automatically sequence through all of the Static Pressure settings, starting with -10 mmHg, incrementing at a fixed interval. The interval may be set in the System Setup Menu under “Auto Step Time.”

NOTE: Each channel can be set independently.

BLOOD PRESSURE	
1) Arterial	120/80
Resp Artifact:	8 mmHg
<hr/>	
2) Static	-10 mmHg (14)
Resp Artifact:	N/A

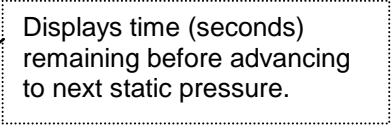
 Displays time (seconds) remaining before advancing to next static pressure.

The  key can be used to exit the Auto Mode during the sequence.

PS-2210

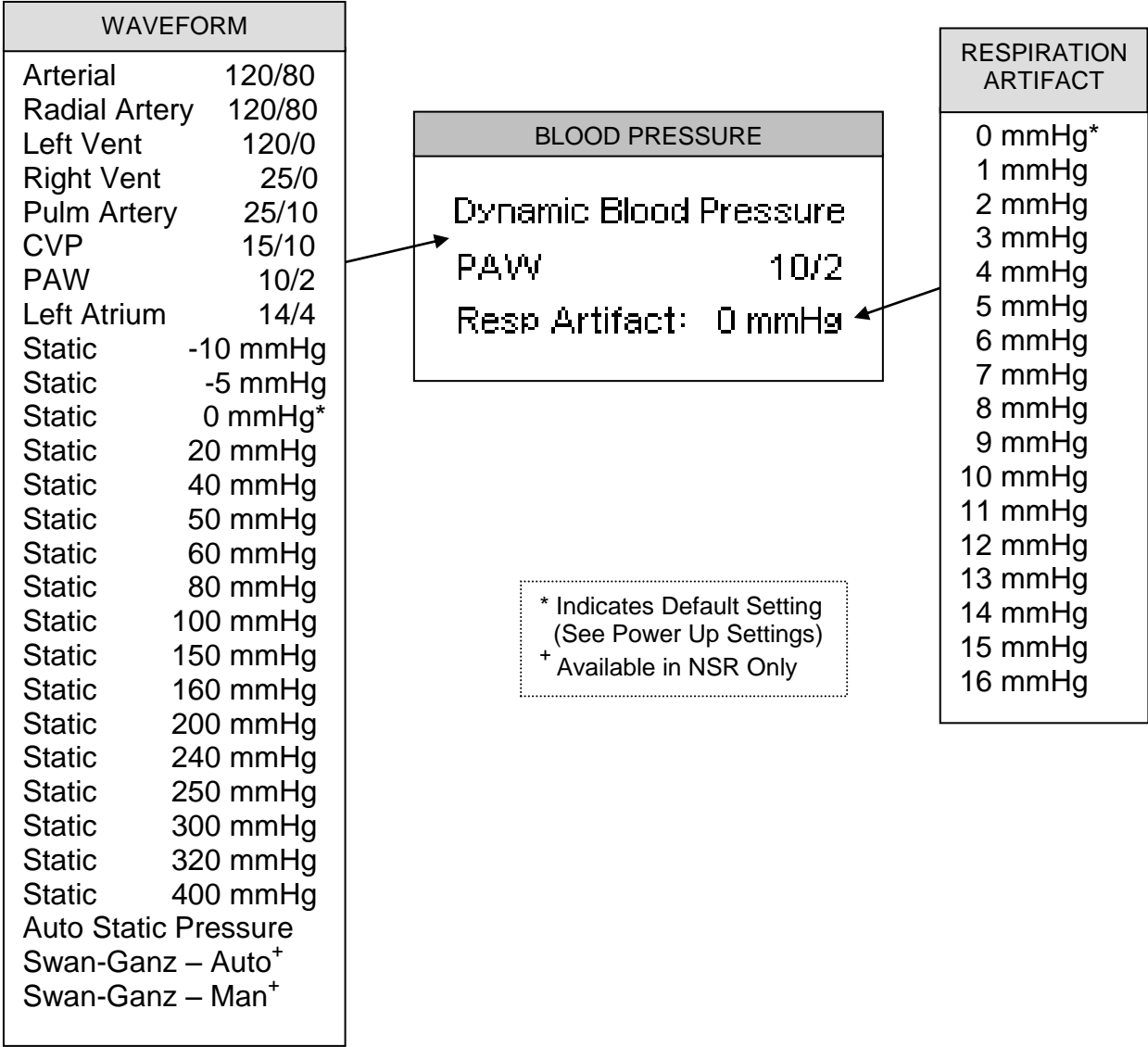

The PS-2210 single blood pressure display will resemble the following:



These settings can be selected by using to highlight the parameter to change and using to scroll to the desired option. Then is used to accept the new setting.

Alternately, to see a submenu of all the options for a highlighted parameter, use



Use   to scroll to the desired option. Then  is used to accept the new setting.

Auto Static Pressure

If Auto Static Pressure is selected, the channel will automatically sequence through all of the Static Pressure settings, starting with -10 mmHg, incrementing at a fixed interval. The interval may be set in the System Setup Menu under “Auto Step Time.”

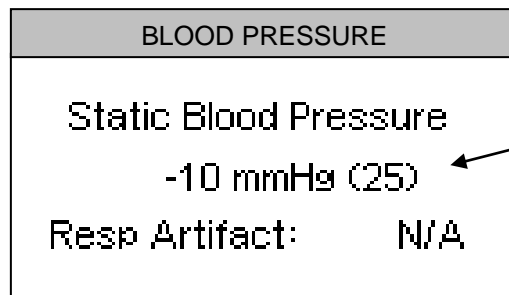





Displays time (seconds) remaining before advancing to next static pressure.

The  key can be used to exit the Auto Mode during the sequence.

SWAN-GANZ

The Swan-Ganz simulation is a special feature that will run the typical sequence for a Swan-Ganz catheter. This can be done either manually, with the user triggering each step, or automatically, with the unit continuously running the sequence with each step at a fixed time interval.

The sequence may be run on any channel while in the Normal Sinus Rhythm screen, but only on one channel at a time. The sequence can be activated by using   to highlight the appropriate channel then using   to scroll to the desired option. Then  is used to select the Swan-Ganz – Man or Swan-Ganz – Auto waveform. When either of these waveforms is selected, a special screen will be displayed to step through the specific Swan-Ganz information.

Manual

In the Swan-Ganz – Man mode, the user controls the sequence using the



keys. (The functions of the keys vary with the steps. The display will

indicate the current options on each screen.)

The following is a typical screen:

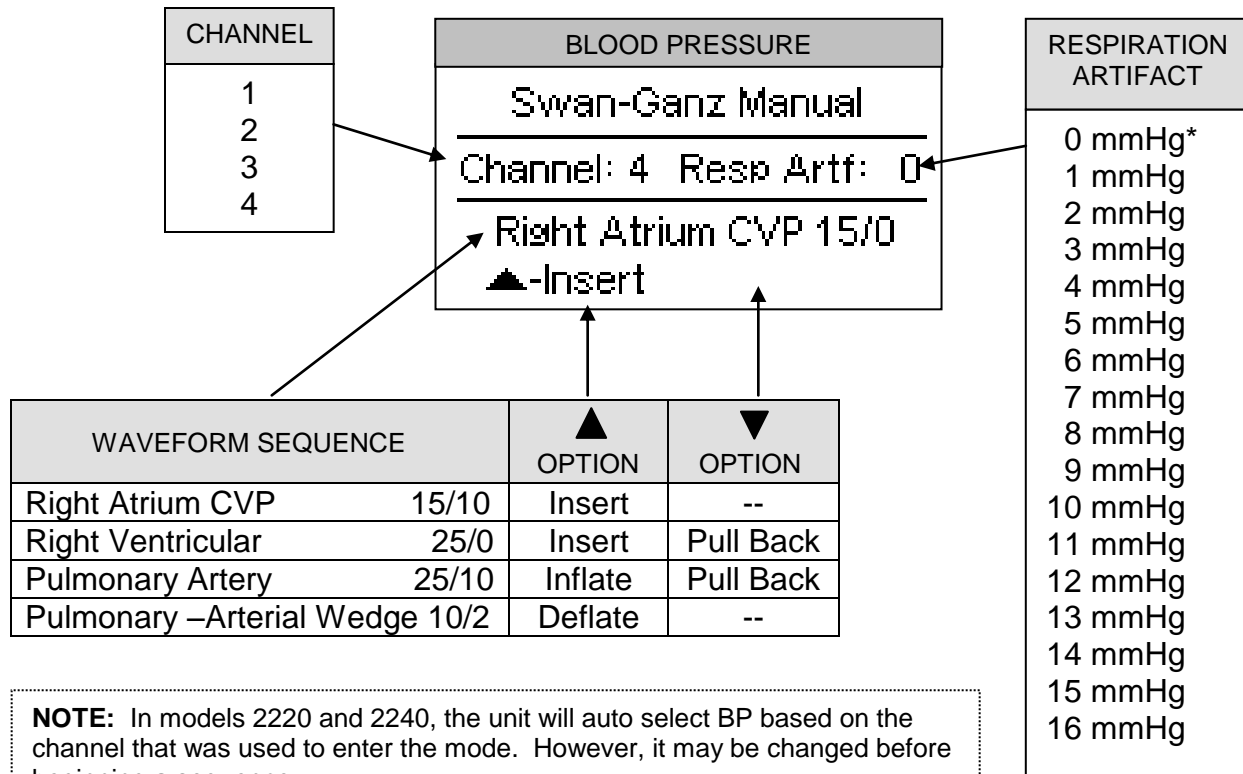

The  key can be used to exit the Manual Mode during the sequence.

Automatic

In the Swan-Ganz – Auto mode, the unit continually runs the sequence. The time remaining before proceeding to the next step is counted down in the display.

The following is a typical setup screen:

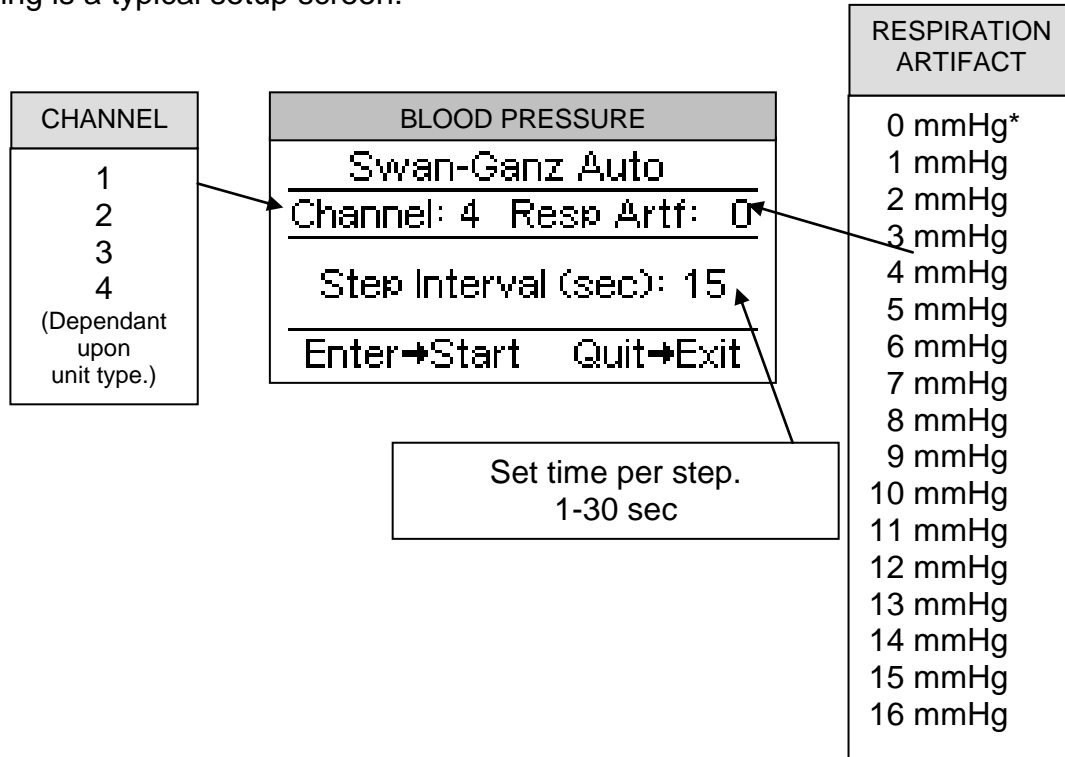

NOTE: In models 2220 and 2240, the unit will auto select BP based on the channel that was used to enter the mode. However, it may be changed before beginning a sequence.

The following is a typical running screen:

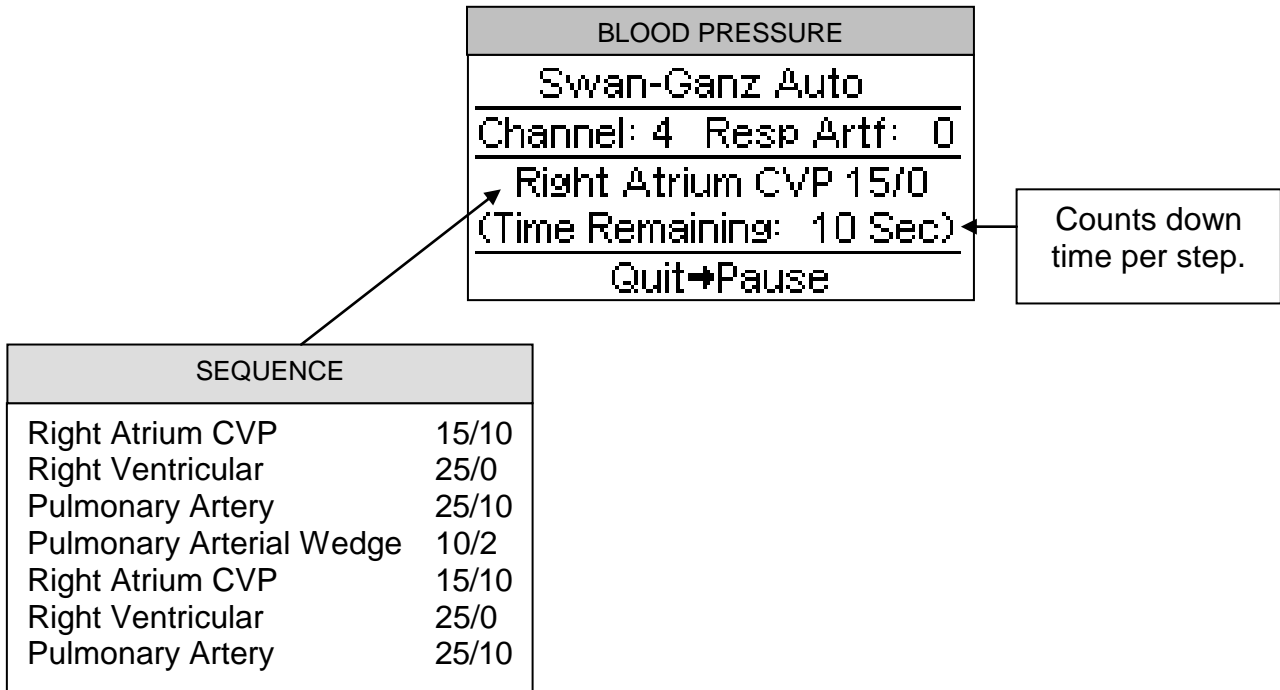

To pause or exit the Swan-Ganz – Auto Mode during a sequence, use . The following message box will be displayed:

Press ENTER to continue.
Press QUIT to exit.





RESPIRATION



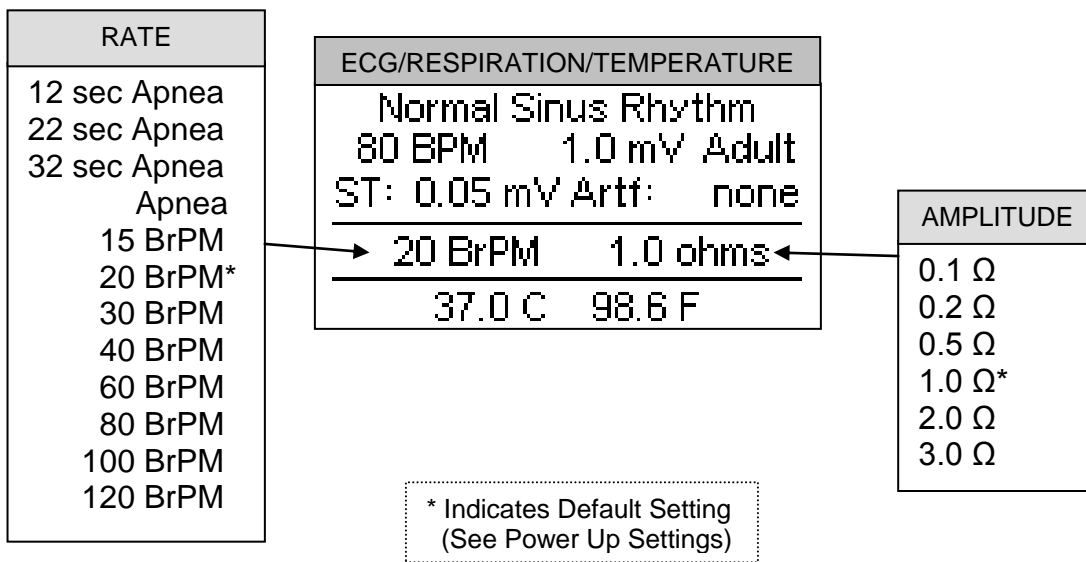

NOTE: The delta ohm Respiration Signal can be inserted in either the LL or LA lead. The Baseline impedance can be set to 500, 1000, 1500 or 2000 Ohms. These must be set to correlate with the monitoring equipment before simulation can begin. (See SETUP for selection information).

There are 12 rate settings available (9 BrPM rates, Apnea (0 BrPM) and 3 timed Apneas).

The display will resemble the following:



These Rates and Amplitude (Impedance Variations) can be selected by using   to highlight the parameter to change and using   to scroll to the desired option. Then  is used to accept the new setting.

Alternately, to see a submenu of all the options for a highlighted parameter, use . Use   to scroll to the desired option. Then  is used to accept the new setting.

Timed Apnea

To trigger a one time event Apnea for one of the specific periods (12, 22 or 32 seconds), simply highlight the desired period and press .

The Respiration display will change as shown in the following typical display:

ECG/RESPIRATION/TEMPERATURE	
Normal Sinus Rhythm	
45 BPM	1.0 mV Adult
ST: 0.05 mV	Artf: none
<hr/>	
Apnea Countdown: 22 sec	
<hr/>	
37.0 C	98.6 F

The display will count down the Apnea period and then revert to the previous BrPM setting, display and output.

The countdown may be manually cancelled with the  key.

TEMPERATURE

The PS-2200 simulates 7 temperatures that are independent from the rest of the functions of the unit. The temperature setting can be selected at any time.

The output will simulate both YSI 400 and YSI 700 Temperature probes.

(Note: Both outputs are available at the output connector simultaneously.)

The display will resemble the following:





ECG/RESPIRATION/TEMPERATURE	
Normal Sinus Rhythm	
80 BPM	1.0 mV Adult
ST: 0.05 mV Artf: none	





20 BrPM	1.0 ohms

37.0 C	98.6 F ←

TEMPERATURE	
0 °C	32.0 °F
24 °C	75.2 °F
30 °C	86.0 °F
35 °C	95.0 °F
37 °C	98.6 °F*
40 °C	104.0 °F
42 °C	107.6 °F

* Indicates Default Setting
(See Power Up Settings)

These temperatures can be selected by using   to highlight the parameter to change and using   to scroll to the desired option. Then  is used to accept the new setting.

Alternately, to see a submenu of all the options for a highlighted parameter, use  . Use   to scroll to the desired option. Then  is used to accept the new setting





TRAINING



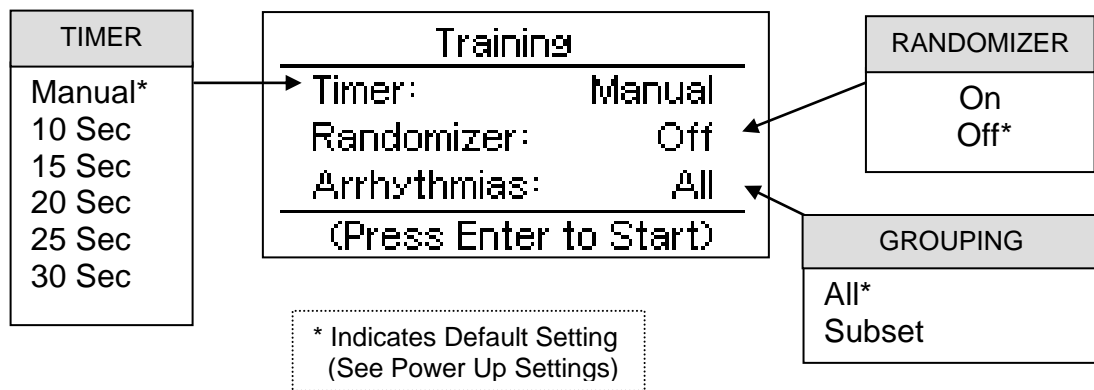

The PS-2200 provides the unique feature of a Training Mode to aid the user in practicing the identification of arrhythmias. The unit will sequence through the arrhythmias, allowing the user to look at the output on their equipment, identify the arrhythmia and then verify their conclusion with the correct name shown on the display. The user can select either manual or timed sequencing, as well as whether the arrhythmias will display in order or randomly. Subsets of the Arrhythmias can be selected to allow for individualization.

The PS-2200 is placed into TRAINING mode by pressing the  category key.

The display will resemble the following:



The Timer, Randomizer and Arrhythmias can be selected by using   to highlight the parameter to change and using   to scroll to the desired option. Then  is used to accept the new setting.

Alternately, to see a submenu of all the options for a highlighted parameter, use . Use   to scroll to the desired option. Then  is used to accept the new setting.

When ready to begin the Training, use . The appropriate arrhythmia screen will be displayed with Training Mode indicated.

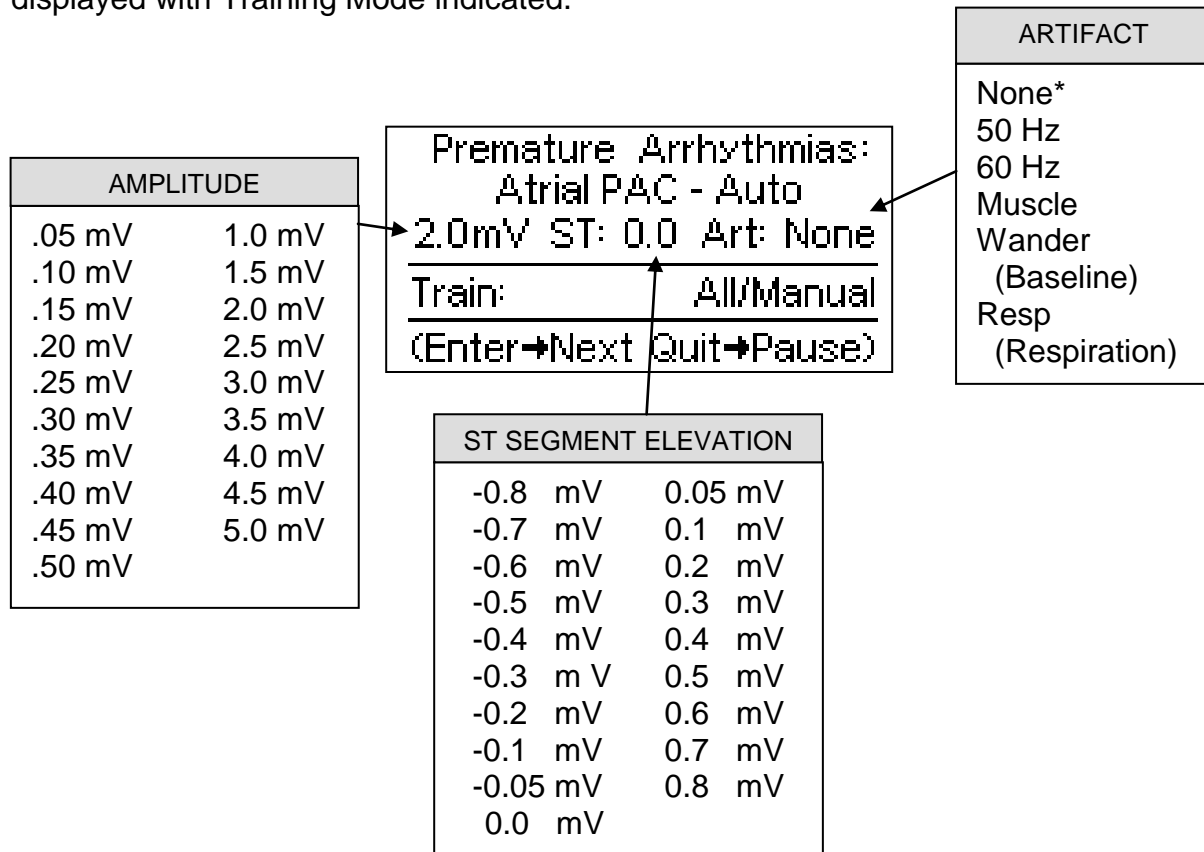

If in the timed mode, the unit will switch to the next arrhythmia automatically at the set time.

If in the manual mode, use  to go to the next arrhythmia when ready.

To pause or exit the Training Mode during a session, use . The following message box will be displayed:

Press ENTER to continue.
Press QUIT to exit.

SUBSET

The subset feature allows the user to select specific arrhythmias for a more controlled training. This feature is selected by setting the “Arrhythmias:” parameter to “Subset.”

The selection of the subset is done by marking those specific arrhythmias or groups of arrhythmias of interest. After a subset of arrhythmias has been selected, it will remain in memory. It may then be edited at any time prior to starting a training session.



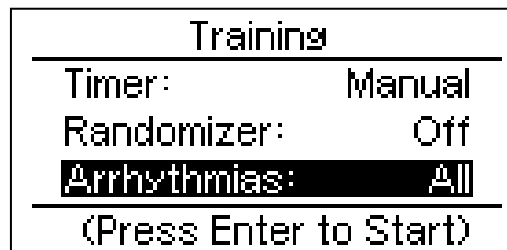

The following procedure is used to modify the subset:

1. From the main screen, highlight Arrhythmias: and use  to open the choices screen.

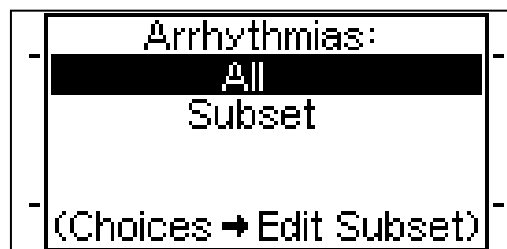





2. Highlight Subset and use  to open the Arrhythmia Groups Submenu screen.

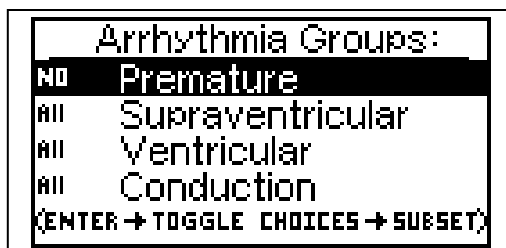

3. To select all the arrhythmias in a group, use   to scroll to the category and  to toggle the indicator to “ALL”. To select none of the arrhythmias in a group, use  to toggle the indicator to “NO”.



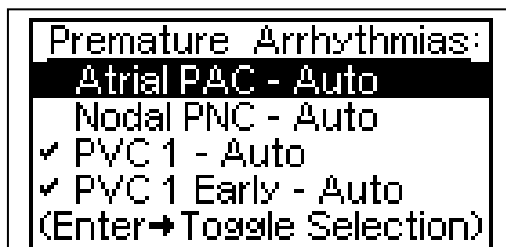

4. To select some of the arrhythmias in a group, use  to display the list of arrhythmias for a specific group. Then use   to scroll through the arrhythmias. Any arrhythmia marked with a check (✓) will be included in the subset. Use  to toggle the selection of an arrhythmia on and off.

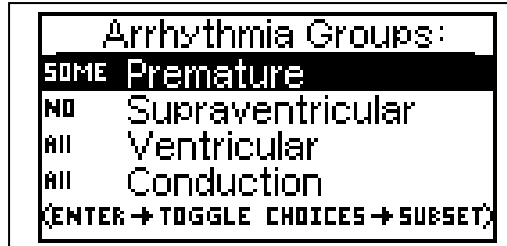

NOTE: If the group is pre-selected with “ALL”, all of the arrhythmias will be checked, thus making it easy to deselect a few. If the group is pre-selected with “NO”, none of the arrhythmias will be checked, thus making it easy to select a few.

5. When completed selecting the desired arrhythmias from that group, use  to return to the Group Submenu. "SOME" will appear to indicate a partial selection of the arrhythmias in that group.,



Additional groups may be modified in the same manor. When done with all the groups, use  again to return to the Training Mode.

SETUP

The PS-2200 allows for setup of the Outputs and the System Parameters through the



category key. Depress the key multiple times to toggle between the setup screens.

The Output Setup screen allows for the setting of the SpO₂ Output, Respiration Baseline Ohms, Respiration Lead and the Blood Pressure Sensitivity parameters. These should be set according to the device under test.

Output Setup

The Output Setup screen allows for the setting of the parameters that control the placement and level of the outputs.

The display will resemble the following:

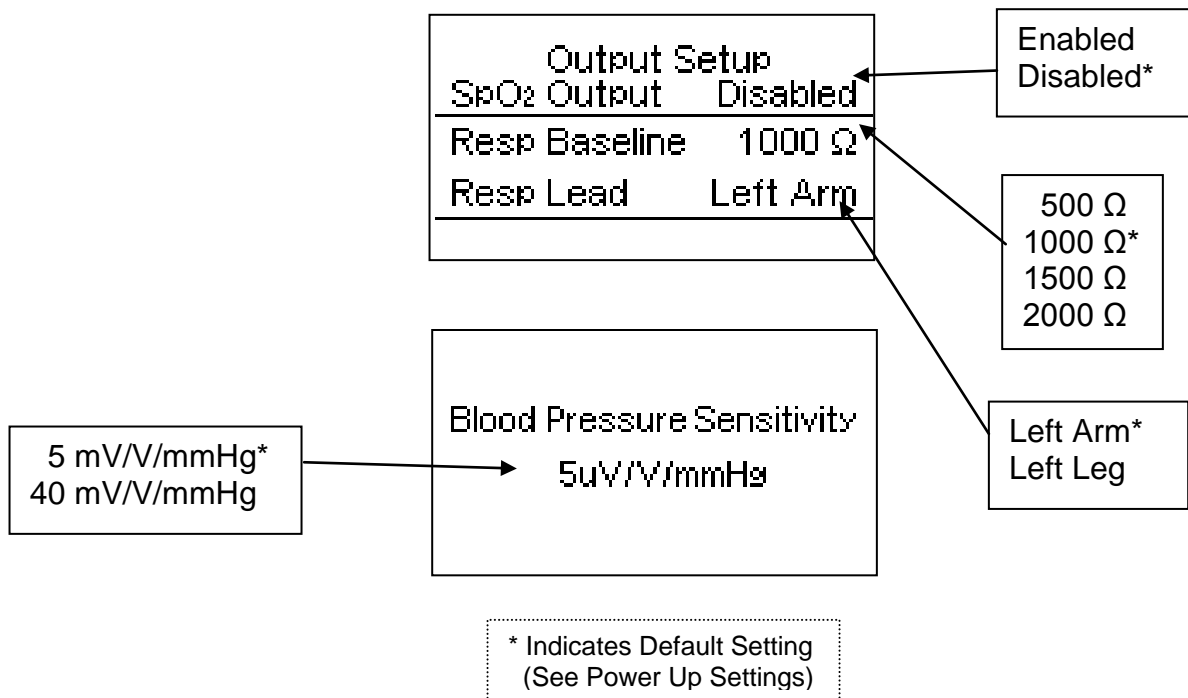

System Setup





The System Setup screen allows for the setting of the parameters controlling various function of the unit as well as the viewing of Battery Life and Software information.

The display will resemble the following:

```
System Setup
Auto Off Timer (Min)  30
Backlight-Timed (sec) 5
Backlight Intensity 100%
Battery Life          100%
Top LCD Contrast      10
```

```
Bottom LCD Contrast  10
Power up with       Defaults
Auto Step Time (sec) 30
Software            DT7347A05G6
```

NOTE: The Software number in this manual is for example purposes only. Specific units may have different software numbers.

These settings can be selected by using   to highlight the parameter to change and using   to scroll to the desired option. Then  is used to accept the new setting.

Use  or ,  or  to exit from the setup screens.

The following is a brief description of the parameters and the available range of settings:

Parameter	Description	Range
Auto Off Timer	The elapsed time after which the unit will automatically power down. This timer is reset by each key depression. (Setting the value to 0 eliminates this feature.)	0-30 min
Backlight Timed	Off – Always off 1-30 sec – The elapsed time after which the backlight will automatically turn off. Manual – The backlight will be manually controlled by backlight key)	Off, 1-30 sec, Manual
Backlight Intensity	Sets the intensity of the backlight. (Note: Lower intensities extend battery life.)	0-100%
Battery Life	Displays current life of the batteries. At 5%, a warning screen will appear. At 10%, the unit will power down automatically.	5-100% (Read Only)
Top LCD Contrast	Sets the contrast of the upper display screen.	0-20
Bottom LCD Contrast	Sets the contrast of the lower display screen.	0-20
Power up with	Selects the values that will be used when the unit is first turned on. It is also used to Set the Custom Defaults, if used. (See Power Up Settings).	Default/Last/ Custom/ Set Custom Defaults
Auto Step Time	Sets the interval that is used with the Auto increment features in BPM, BP Rate and Performance.	1 to 60 sec
Software	Displays current software program.	(Read Only)

POWER UP SETTINGS

The PS-2200 allows the user to tailor the settings that the unit will have on Power Up. The “Power Up With” parameter in the System Setup Menu allows for the selection of either Default, Last or Custom selections.

Default

If this option is selected the following settings will be used every time the unit is turned on.

ECG – NSR: 80 BPM, 1.0 mV, Adult QRS, 0.0 mV ST Elevation, Artifact - None,

SpO₂ Output Disabled

ECG – Arrhythmia: 1.0 mV, Artifact - None, 0.0 mV ST Elevation,

Premature - Atrial PAC - Auto

ECG – Pacemaker: Pulse Amplitude 5 mV, Pulse Width 1.0 ms, Atrial Waveform,

1.0 mV, 0.0 mV ST Elevation, Artifact - None,

ECG – Performance: 2 Hz Square Wave, 1.0 mV,

R-Wave Width 10 ms, R-Wave Rate 60 BPM

Respiration: 20 BrPM, delta 1.0 ohms, 1000 ohms baseline, LA lead

Blood Pressure: 0 mmHg, 5 uV/V/mmHg sensitivity, 0 mmHg Respiration Artifact

Temperature: 37 C (98.6 F)

Fetal/Maternal: Fhr 120 BPM, Mhr 80 BPM, Manual, Uniform Deceleration

Cardiac Output: Test – Normal, Rate - 2.5 L/min, Injectate- 0 °C

SystemSetup:

Auto Timer Off	30 min
Backlight Time	5 sec
Backlight Intensity	100%
Contrast Adjust	10
Power Up With	Default
Auto Step Time	5 sec
Swan-Ganz Step Time	15 sec

Last

If this option is selected, the unit will remember the settings that were being used when it was turned off and bring them back when the power is turned on.

Custom

If this option is selected, the user may save a unique set of default parameters and the unit will recall them every time the power is turned on.

Set Current as Custom

To create the set of custom default parameters, this fourth choice is provided in this parameter. The user simply configures the unit to the desired default conditions, selects this option and presses . The current configuration is then saved as the Custom Power up values.

SpO₂ (Option)

The PS-2200 has the ability to drive an external SpO₂ module. This module (MSP-2100) accepts the FingerSim family of SpO₂ finger simulators (fingers are available with SpO₂ of 80, 90 and 97 %). The output pulses the fingers at the NSR BPM rate (up to 180 BPM). The output is off in Arrhythmia and Performance Modes.

The module plugs directly into the AUX (7 pin mini din) connector and is powered from the PS2200. The output is only functional when the unit is powered from the Battery Eliminator provided with the MSP-2100 Module, since the batteries do not have enough power to run this option.

The output is enabled and disabled in the Setup Output screen.



FETAL / MATERNAL (Option)

The PS-2200 has the ability to simulate a combined Fetal/Maternal ECG. It assumes a Fetal Scalp Electrode and a Maternal Thigh Electrode. Additionally, it produces a pressure waveform to simulate uterine contractions. The waveform may be triggered manually or set to occur periodically. The Intrauterine-Pressure (IUP) curve causes a change in the Fetal Heart Rate (FHR) based on the type of reaction selected. The IUP waveform is on Blood Pressure Channel 1 (BP1) and simulates an Intra-Amniotic catheter connected to a pressure transducer.

The display will resemble the following:

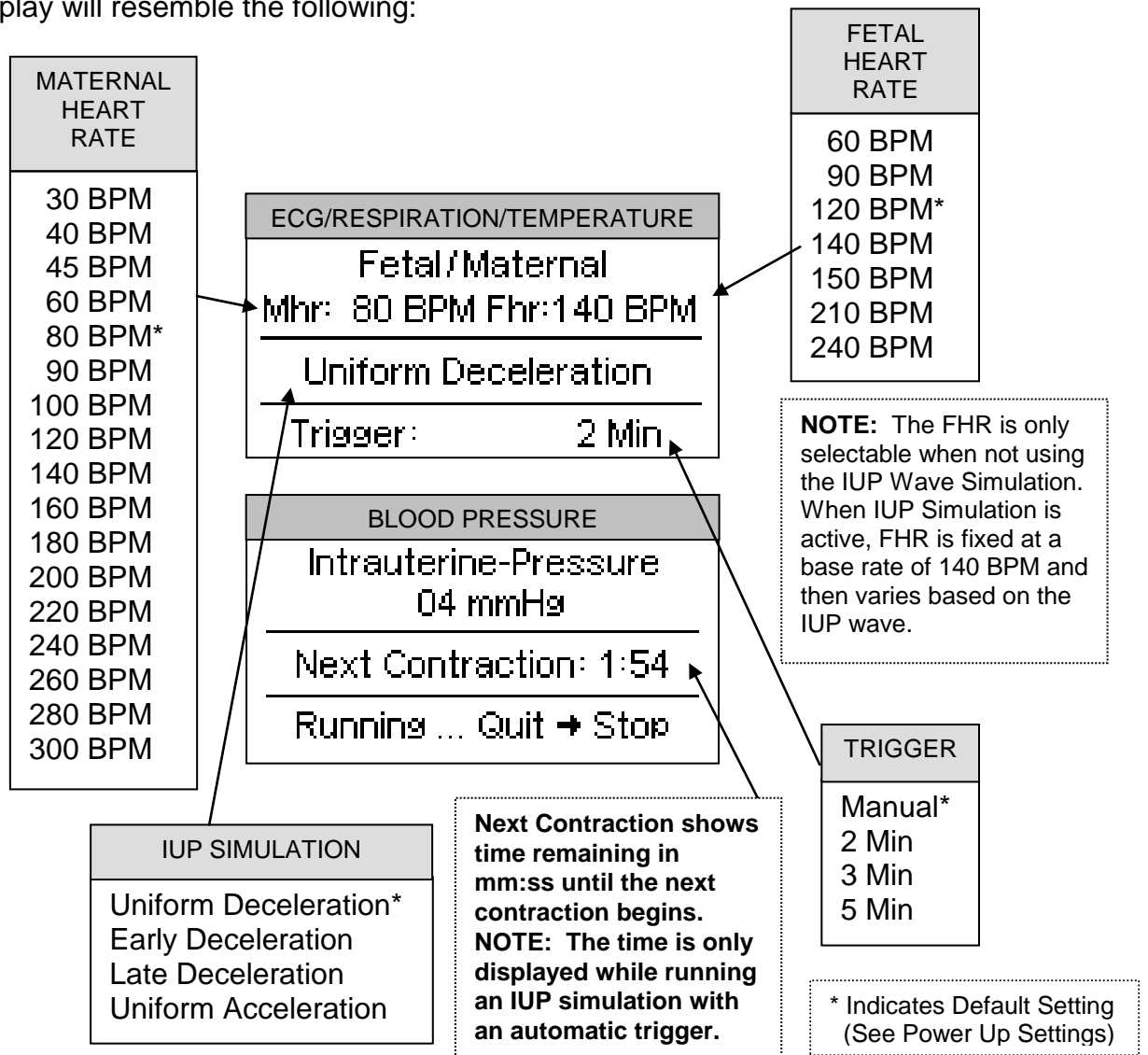

NOTE: The Transducer Sensitivity (5 mV/V/mmHg or 40 mV/V/mmHg) must be set to correlate with the monitoring equipment before simulation can begin. (See SETUP for selection information).

IUP Simulation

This feature is designed to simulate the IUP and corresponding FHR that might occur during labor. The base 140 BPM FHR will respond to the contractions based on the setting as follows:

IUP Simulation Type	FHR Response
Uniform Deceleration	The FHR goes from 140 BPM down to 100 BPM and back again. The rate follows the 90 seconds bell curve of the contraction but is delayed by 30 seconds.
Early Deceleration	The FHR goes from 140 BPM down to 100 BPM and back again. The rate follows the 90 seconds bell curve of the contraction.
Late Deceleration	The FHR goes from 140 BPM down to 100 BPM and back again. The rate follows the 90 seconds bell curve of the contraction but is delayed by 45 seconds.
Uniform Acceleration	The FHR goes from 140 BPM up to 175 BPM and back again. The rate follows the 90 seconds bell curve of the contraction.

The IUP Wave is a bell-shaped curve with a peak of 90 mmHg and duration of 90 seconds. When active, the FHR and IUP displays continuously update to show the current output values. The Trigger is set by selecting Manual, 2, 3 or 5 minutes.

If Manual is selecting, the  key is used to start one contraction.

If a Time is selected, the  key is used to start a continuous cycle with a contraction IUP wave starting every 2, 3 or 5 minutes.

The  key may be used at any point to cancel the simulation run.

CARDIAC OUTPUT (Option)

The PS-2200 has the ability to simulate Thermodilution Cardiac Output measurements. Thermodilution allows the calculation of heart volume output by measuring the temperature change of the blood after a specific volume of solution, which is room temperature or cooler (typically 0 °C or 24 °C), is injected into the heart. The blood temperature is measured by a thermistor on the catheter. The PS-2200 simulation provides an output curve that the Device Under Test (DUT, Cardiac Output Monitor) takes as a blood temperature input.

The PS-2200 drives an external Cardiac Output module. This module (MCO-2100) provides both a common connection point for the cabling and a manual simulation setting for the injectate temperature. Abnormal waveforms are provided to simulate Injectate Failure and Left-to-Right Shunt conditions. A special Calibration Pulse that puts out a 1.5 °C drop in the temperature is also provided.

The display will resemble the following:

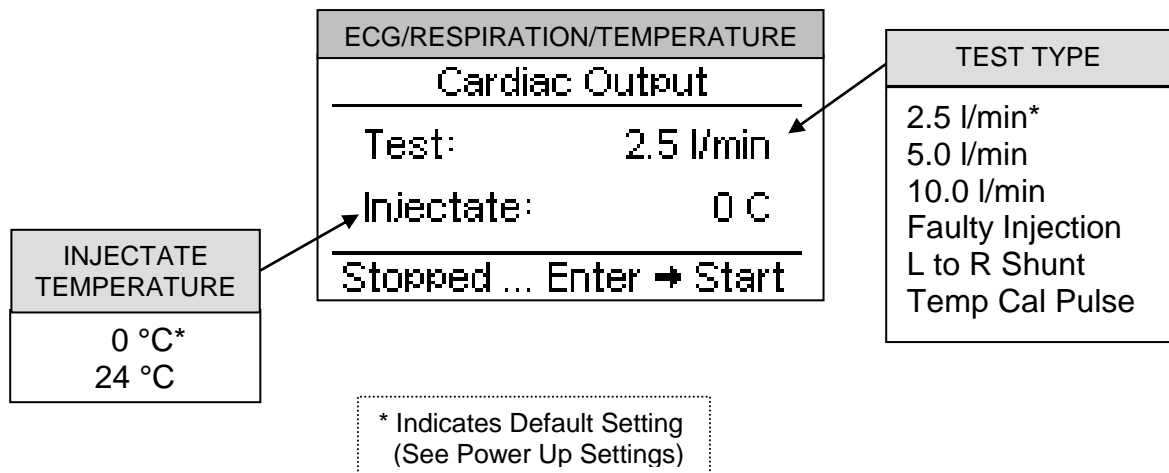

Setting Up a Test

- 1) The DUT (Cardiac Output Monitor) needs to be setup to match the PS-2200. The following settings are required:

Catheter	Baxter Edwards 93a – 131 – 7f
Calibration Coefficient	0.542 for 0 °C Injectate 0.595 for 24 °C Injectate
Injectate Volume	10 cc
Injectate Temperature	0 °C or 24 °C

- 2) Connect MCO-2100 Module to the CO/Temp port on the PS-2200.
- 3) Connect the Blood Temperature Sensor Line (BT Thermistor Cable) from the DUT to the small 4-pin connector on the MCO-2100.
- 4) Connect the Injectate Temperature Sensor Line for the DUT to the larger 4-pin connector on the MCO-2100.
- 5) Turn on the DUT and the PS-2200. The DUT should show a blood temperature of about 37 °C.
- 6) Adjust the trim pot on the MCO-2100 Module until the DUT shows the desired injectate temperature (0 °C or 24 °C)



Running a Test

1) Select the desired test.

Normal	This test allows the selection of a flow rate (2.5, 5.0 or 10.0 L/min). When run, it will produce the normal temperature curve for the selected injectate temperature (0 °C or 24 °C). The DUT should interpret this as the selected flow rate.
Faulty Injectate	This is an abnormal output meant to simulate a condition where the injectate is not delivered in a smooth flow.
Left-to-Right Shunt	This is an abnormal output meant to simulate a physiological condition where the blood is shunted across the heart rather than to the lungs.
Temperature Calibration Pulse	This is a calibration output waveform that drops the normal 37 °C temperature output to 35.5 °C for 1 second.

2) Select the injectate temperature (0 °C or 24 °C).

NOTE: This is different than the selection made on the MCO-2100, which sets the injectate temperature on the DUT. This tells the PS-2200 which injectate temperature to simulate.

3) Select the desired flow for simulation (Normal Test only).

4) Use the  key to start the test.

5) The test will run one complete cycle. Use the  key to repeat as often as desired.

The  key may be used at any point to terminate the cycle.

OUTPUT CONNECTIONS

The following are representations of the socket connectors found on the unit. They are viewed as if looking at the socket in the unit, not the cable pins.

BP CONNECTOR

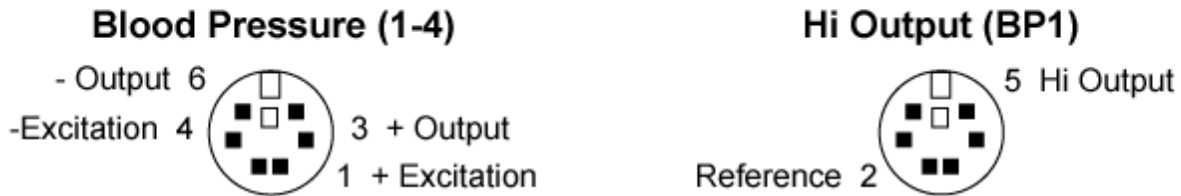

TEMP CONNECTOR

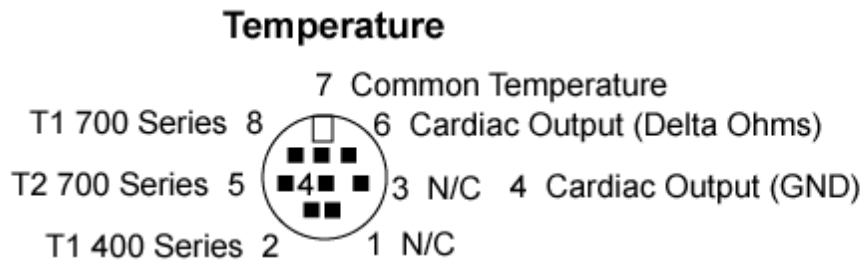

AUX CONNECTOR

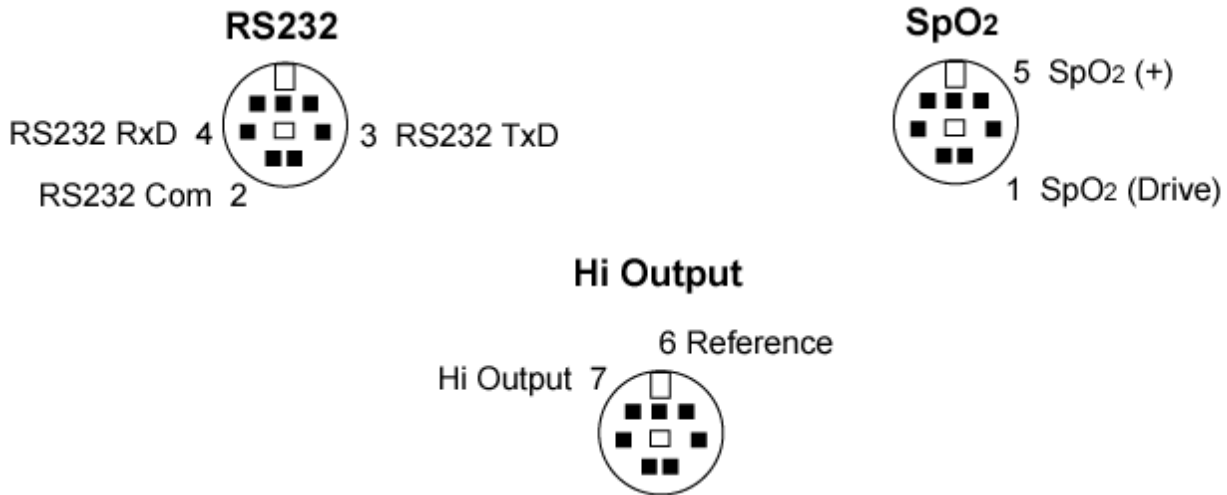

MANUAL REVISIONS

<u>Revision #</u>	<u>Program #</u>	<u>Revisions Made</u>
Rev 01	DT7347CA	Preliminary Manual
Rev 02	DT7347CA	Updates to Preliminary Manual
Rev 03	DT7347CA	Edits to Preliminary Manual
Rev 04	DT7347CA	Overlay Additions
Rev 05	DT7347CB	Miscellaneous Edits
Rev 06	DT7347CB	Battery Eliminator Specifications Updated
Rev 07	DT7347CE	Pictures Updated
Rev 08	DT7347CE	Update Address
Rev 09	DT7347CG	Warning, Cautions, Notices, CE and Misc Edits
Rev 10	DT7347CG	Cardiac Output Instructions Updated
Rev 11	DT7347CG	Format Updated, Misc. Edits

LIMITED WARRANTY

WARRANTY: BC GROUP INTERNATIONAL, INC. WARRANTS ITS NEW PRODUCTS TO BE FREE FROM DEFECTS IN MATERIALS AND WORKMANSHIP UNDER THE SERVICE FOR WHICH THEY ARE INTENDED. THIS WARRANTY IS EFFECTIVE FOR TWELVE MONTHS FROM THE DATE OF SHIPMENT.

EXCLUSIONS: THIS WARRANTY IS **IN LIEU OF** ANY OTHER WARRANTY EXPRESSED OR IMPLIED, INCLUDING, BUT NOT LIMITED TO ANY IMPLIED WARRANTY OF **MERCHANTABILITY** OR FITNESS FOR A PARTICULAR PURPOSE.

BC GROUP INTERNATIONAL, INC. IS NOT LIABLE FOR ANY INCIDENTAL OR CONSEQUENTIAL DAMAGES.

NO PERSON OTHER THAN AN OFFICER IS AUTHORIZED TO GIVE ANY OTHER WARRANTY OR ASSUME ANY LIABILITY.



REMEDIES: THE PURCHASER'S SOLE AND EXCLUSIVE REMEDY SHALL BE: (1) THE REPAIR OR REPLACEMENT OF DEFECTIVE PARTS OR PRODUCTS, WITHOUT CHARGE. (2) AT THE OPTION OF **BC GROUP INTERNATIONAL, INC.**, THE REFUND OF THE PURCHASE PRICE.

SPECIFICATIONS

ECG SIMULATION			
RATE	NSR	30, 40, 45, 60, 80, 90, 100, 120, 140, 160, 180, 200, 220, 240, 260, 280, 300 BPM	
	PERFORMANCE WAVEFORMS	SINE	0.1, 0.5, 5, 10, 40, 50, 60, 100 Hz
		SQUARE	0.125, 2.000 Hz
		TRIANGLE	2.000, 2.500 Hz
		PULSE	30, 60, 120 BPM
		R-WAVE	30, 60, 80, 120, 200, 250 BPM
ACCURACY	± 1%		
WIDTH	PULSE	60 ms	
	R-WAVE (HAVERTRIANGLE)	8, 10, 12, 20, 30, 40, 50, 60, 70, 80, 90, 100, 120, 130, 140, 150, 160, 170, 180, 190, 200 ms	
AMPLITUDE	0.05, 0.10, 0.15, 0.20, 0.25, 0.30, 0.35, 0.40, 0.45, 0.50, 1.0, 1.5, 2.0, 2.5, 3.0, 3.5, 4.0, 4.5, 5.0 mV		
	ACCURACY	± 2% @ Lead II Except for R-WAVE ≤ 20 ms: ± 5% @ Lead II	
HIGH LEVEL	200 times Amplitude		
	ACCURACY	± 5%	
QRS INTERVAL	Adult (80 ms), Pediatric (40 ms)		
ST SEGMENT (ELEVATION)	± 0, 0.05, 0.1, 0.2, 0.3, 0.4, 0.5, 0.6, 0.7, 0.8 mV		
LEAD TO LEAD IMPEDANCE	RL, LL, RA, LA	500, 1000, 1500, 2000 Ω	
	V1-V6	1000 Ω	

PACEMAKER WAVEFORMS		
RATE	75 BPM	
	ACCURACY	± 1%
WIDTH	0.1, 0.5, 1.0, 1.5, 2.0 ms	
	ACCURACY	± 5%
AMPLITUDE	1, 2, 3, 4, 5, 6, 7, 8, 9, 10 mV	
	ACCURACY	± 10%
IBP SIMULATION		
CHANNELS	PS-2210	1
	PS-2220	2
	PS-2240	4
STATIC PRESSURE	-10, -5, 0, 20, 40, 50, 60, 80, 100, 150, 160, 200, 240, 250, 300, 320, 400 mmHg	
	ACCURACY	± (2% of Reading + 2 mmHg)
IMPEDANCE	300 Ω	
	ACCURACY	± 10%
EXCITATION RANGE	2 to 16 V RMS	
EXCITATION FREQUENCY	DC to 5 kHz	
SENSITIVITY	5 or 40 μV/V/mmHg	
RESPIRATION ARTIFACT	0 to 16 mmHg	
RESPIRATION SIMULATION		
RATE	Apnea, 15, 20, 30, 40, 60, 80, 100, 120 BrPM	
	ACCURACY	± 1%
IMPEDANCE DELTA	0.1, 0.2, 0.5, 1.0, 2.0, 3.0 Ω	
	ACCURACY	± 10%
BASELINE	500, 1000, 1500, 2000 Ω	
	ACCURACY	± 5%
LEAD	LA or LL	

TEMPERATURE SIMULATION		
SELECTION	0, 24, 30, 37, 40 °C (32.0, 75.2, 86.0, 98.6, 104.0 °F)	
ACCURACY	± 0.1 °C	
TYPE	YSI Series 400 and 700	
FETAL / MATERNAL SIMULATION		
FETAL HEART RATE	60, 90, 120, 140, 150, 210, 240 BPM	
INTER UTERINE PRESSURE RESPONSE TYPES	Uniform Deceleration Early Deceleration Late Deceleration Uniform Acceleration	
IUP WAVE	Bell Curve with 90 mmHg Peak and 90 second Width	
IUP TRIGGER	Manual Auto: 2, 3, 5 minutes	
CARDIAC OUTPUT		
INJECTATE VOLUME	10 cc	
INJECTATE TEMPERATURE	0 or 24 °C	
	ACCURACY	± 2%
INJECTATE CALIBRATION COEFFICIENT	0 °C	0.542
	24 °C	0.595
BLOOD TEMPERATURE	37 °C (98.6 °F)	
	ACCURACY	± 2%
CARDIAC OUTPUT	2.5, 5.0, 10.0 L/min,	
	ACCURACY	± 5%
SIMULATIONS	Normal Flow Faulty Injectate Left-to-Right Shunt Temperature Calibration Pulse	
TEMPERATURE CALIBRATION PULSE	1.5 °C Down for 1 sec	
	ACCURACY	± 1%
CATHETER TYPE	Baxter Edwards, 93a-131-7f	

PHYSICAL & ENVIRONMENTAL		
DISPLAY	Two 128 X 64 Pixel Graphical LCDs, White LED Backlight	
CONSTRUCTION	ENCLOSURE	ABS Plastic
	FACE PLATE	Lexan, Back printed
SIZE	8.97 x 6.04 x 1.72 Inches (227.8 x 153.4 x 43.7 mm)	
WEIGHT	≤ 2 Lbs (0.91 kg)	
OPERATING RANGE	15 to 40 °C (59 to 104 °F)	
STORAGE RANGE	-20 to 65 °C (-4 to 149 °F)	
ELECTRICAL		
BATTERY	9V Alkaline Battery (2 required) (ANSI/NEDA 1604A or equivalent)	
BATTERY ELIMINATOR	WITHOUT MSP-2100	9 VDC, 200 mA  BC20-21100 (USA Version) BC20-21101 (Euro Version)
	WITH MSP-2100	10 VDC, 500 mA  BC20-21103 (USA Version) BC20-21101 (Euro Version)

NOTES



**BC GROUP INTERNATIONAL, INC.
3081 ELM POINT INDUSTRIAL DRIVE
ST. CHARLES, MO 63301
USA**

**1-800-242-8428
1-314-638-3800**

**www.bcgrouptl.com
sales@bcgrouptl.com**

**PS-2200 Series User Manual
10/12 – Rev 11**

**Copyright © 2012
Made in the USA**